

Instruction Manual (Supplementary) Totally-Enclosed Box Type Inverter TOSVERT VF-FS1

Thank you for purchasing a Toshiba "totally-enclosed box type TOSVERT VF-FS1 series inverter."
This Manual gives a supplementary explanation of some items referred to in the instruction manual E6581381 included with the product. Please read this manual carefully along with the instruction manual E6581381.



- To set makers -

Please see to it that this manual is supplied to the inverter's end user, along with the instruction manual E6581381.



■ Safety precautions

Before reading this manual, please read the following instructions in addition to "I. Safety Precautions," of the instruction manual E6581381.

■ General Operation

 Danger	
 Mandatory	<ul style="list-style-type: none"> • Circuit boards are exposed when the front cover is removed. So do not detach the front cover when the inverter is energized or within 10 minutes after power is turned off. Doing so could result in electric shock.

■ Transportation

 Warning	
 Mandatory	<ul style="list-style-type: none"> • In case of up to 7.5kW-inverter unit, when handling the inverter unit, hold it by both the sides firmly. If you hold it by the fins at the upper and lower parts, you could get injured. • For a model designed 11kW or larger, carry it at least in a twosome, or it could fall and cause you to get an injury.

■Exterior Features

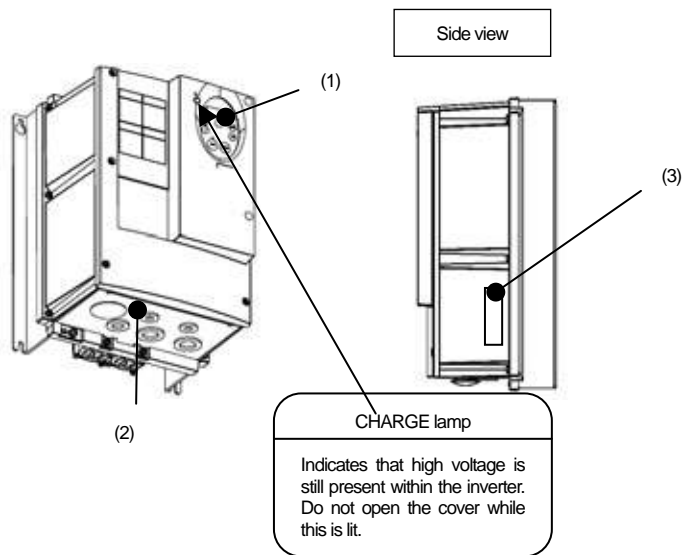

No.	Devices	Remarks
(1)	Operation panel	Equipped with ▲, ▼, MODE and ENT keys used to set parameters, RUN and STOP used to drive the motor, LOC/REM used to change local and remote, a 7-segment LED and a CHARGE lamp.
(2)	Wiring port plate	Steel plate with wiring ports. The effects of noise can be reduced to some degree by fixing shielded parts of cables with cable grounds or similar devices. See page 26.
(3)	Name plate	Label on which the ratings of the inverter unit is printed.

■Power circuit terminal

In case of the lug connector, cover the lug connector with insulated tube, or use the insulated lug connector.

The input terminal board of VFFS1-4110PDE – 4185PDE has terminals of a cable pinch type. And, the main circuit terminal board of VFFS1-4220PLE – 4750PLE and VFFS1-4220PDE – 4750PDE has terminals of a cable pinch type.

Before connecting a cable, strip off its sheath to a length of as below table.

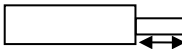

Recommended stripping
length is below table

Type-form VFFS1-	Input terminal R/L1,S/L2,T/L3		Recommen d length for cable pinch type [mm]	Output terminal U/T1,V/T2,W/T3		Recommen d length for cable pinch type [mm]	Grounding terminal	
	Terminal screw size	Torque		Terminal screw size	Torque		Terminal screw size	Torque
4007PL1E 4007PDE	M4	1.3N · m /10.7lb · in	-	M4	1.3N · m /10.7lb · in	-	M5	2.5N · m /22.3lb · in
4015PL1E 4015PDE								
4022PL1E 4022PDE								
4037PL1E 4037PDE	M4	1.3N · m /10.7lb · in	-	M4	1.3N · m /10.7lb · in	-	M5	2.5N · m /22.3lb · in
4055PLE 4055PDE								
4075PLE 4075PDE	M5	2.5N · m /22.3lb · in	-	M5	2.5N · m /22.3lb · in	-	M5	2.5N · m /22.3lb · in
4110PLE	M5	3.0N · m /26.6lb · in	-	M5	3.0N · m /26.6lb · in	-	M5	3.0N · m /26.6lb · in
4150PLE								
4185PLE	M6	5.4N · m /47.8lb · in	-	M6	5.4N · m /47.8lb · in	-	M5	3.0N · m /26.6lb · in
4220PLE	M10	24N · m /212lb · in	22.0	M10	24N · m /212lb · in	22.0	M5	3.0N · m /26.6lb · in
4300PLE								
4370PLE								
4450PLE								
4550PLE	M16	41N · m /360lb · in	34.0	M16	41N · m /360lb · in	34.0	M8	12N · m /106lb · in
4750PLE								
4110PDE	M4	1.7N · m /15.2lb · in	11.0	M5	3.0N · m /26.6lb · in	-	M5	3.0N · m /26.6lb · in
4150PDE								
4185PDE	M5	2.2N · m /19.6lb · in	16.0	M6	5.4N · m /47.8lb · in	-	M5	3.0N · m /26.6lb · in
4220PDE	M5	4.3N · m /38.4lb · in	19.0	M10	24N · m /212lb · in	22.0	M5	3.0N · m /26.6lb · in
4300PDE								
4370PDE	M6	7N · m /62.6lb · in	24.0	M10	24N · m /212lb · in	22.0	M5	3.0N · m /26.6lb · in
4450PDE								
4550PDE	M12	25N · m /221lb · in	27.0	M16	41N · m /360lb · in	34.0	M8	12N · m /106lb · in
4750PDE								

VFFS1-4007PL1E-4022PL1E

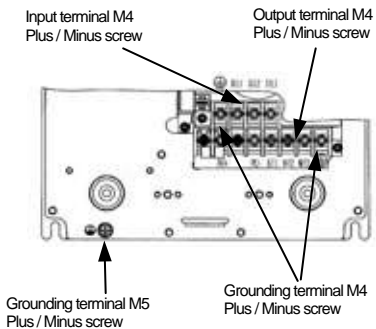

VFFS1-4007PDE-4022PDE

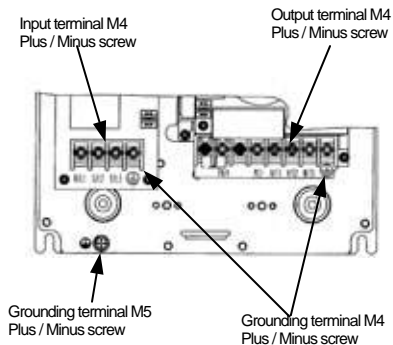

VFFS1-4037PL1E, 4055PLE

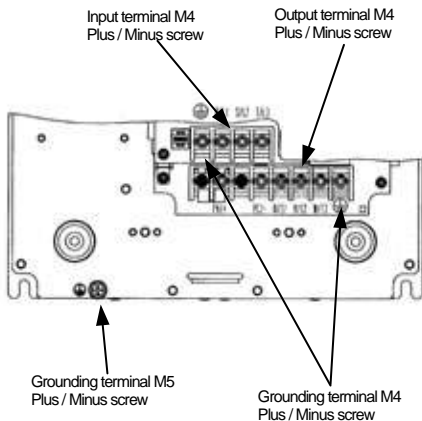

VFFS1-4037PDE-4055PDE

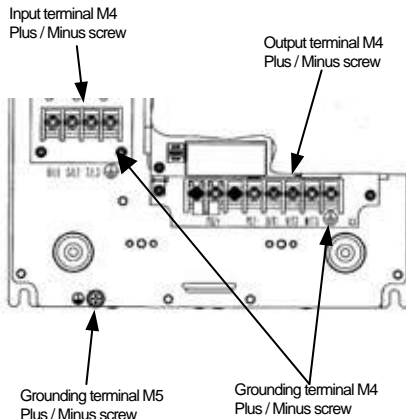

VFFS1-4075PLE / 4075PDE

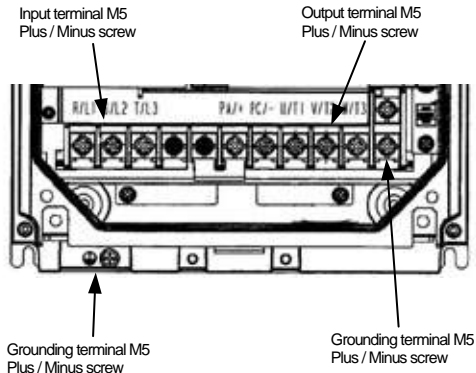

VFFS1-4110PLE-4150PLE

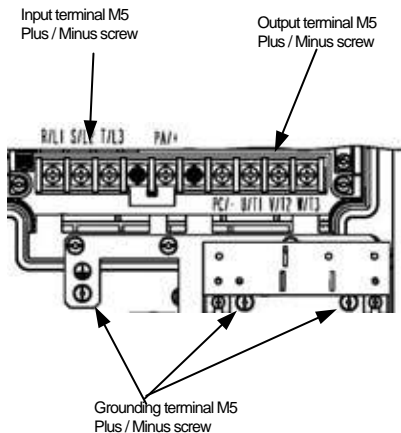

VFFS1-4110PDE-4150PDE

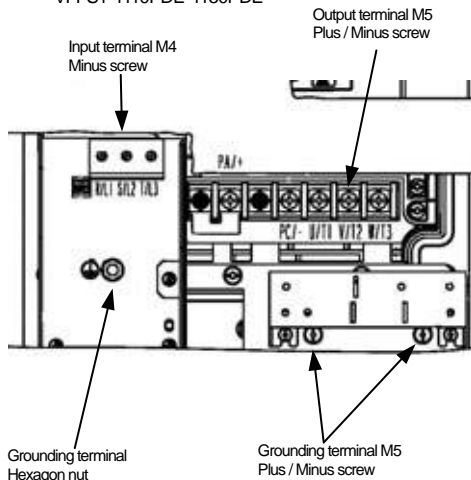

VFFS1-4185PLE

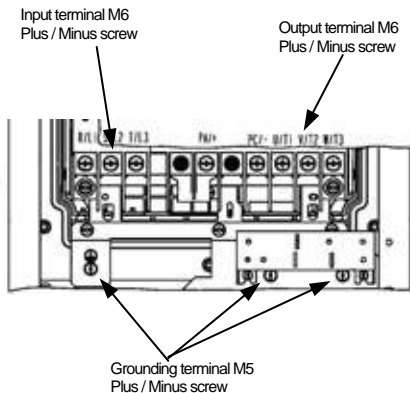

VFFS1-4185PDE

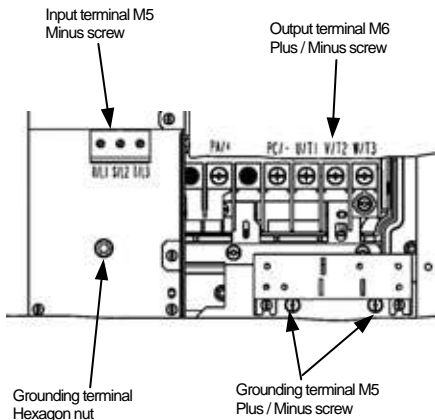

VFFS1-4220PLE-4450PLE

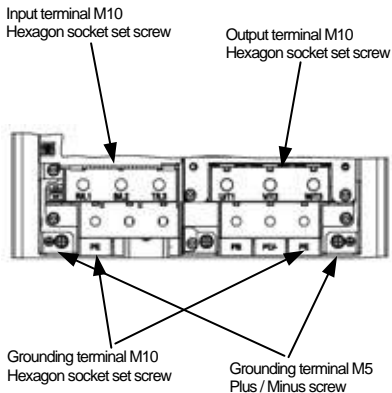

VFFS1-4220PDE-4450PDE

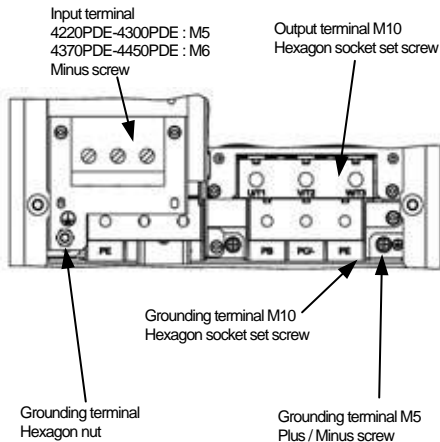

VFFS1-4550PLE-4750PLE

Input terminal M16
Hexagon socket set screw

Output terminal M16
Hexagon socket set screw

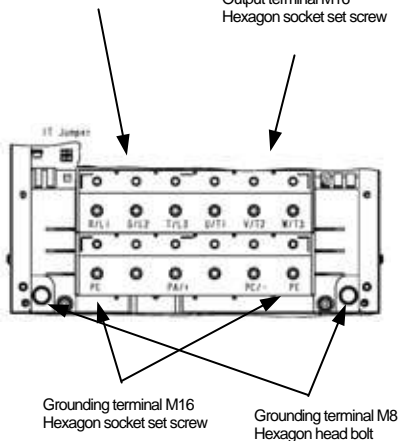

Grounding terminal M16
Hexagon socket set screw

Grounding terminal M8
Hexagon head bolt

VFFS1-4550PDE-4750PDE

Input terminal M12
Hexagon socket set screw

Output terminal M16
Hexagon socket set screw

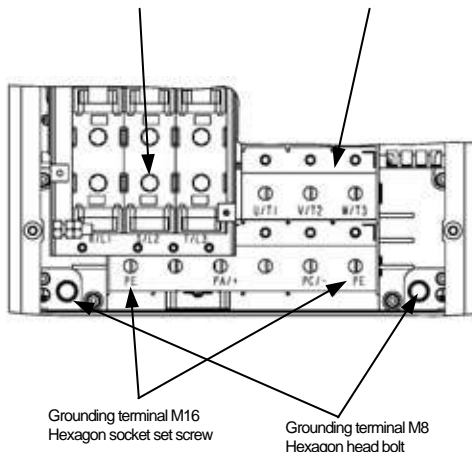

Grounding terminal M16
Hexagon socket set screw

Grounding terminal M8
Hexagon head bolt

■How to open the front and control circuit terminal (0.75kW – 7.5kW)

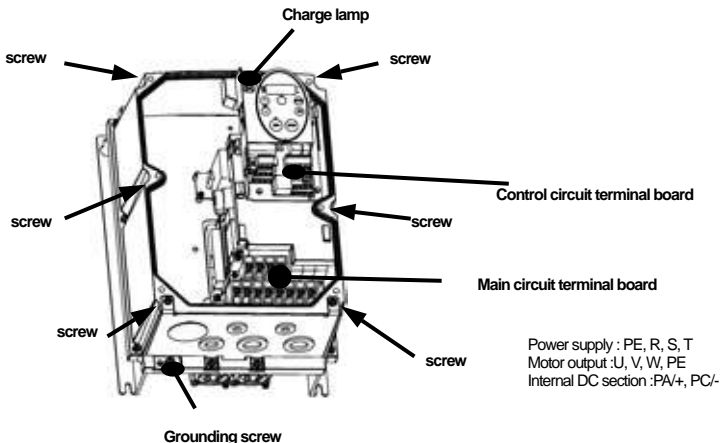

How to remove the front cover

1. Shut off the supply of electricity from the main power supply.
2. Ten minutes or more after turning off power, check to be sure that the CHARGE lamp is not lit.
3. Remove the 6 screws (indicated by the arrows in the figure) around the front cover.

How to attach the front cover

1. Attach the front cover.
2. Set and tighten the 6 screws (indicated by the arrows in the figure) around the front cover.

Caution: Attach the front cover securely.
 Or else it does not serve as a protector compliant with IP54.
 On top of that, it may become impossible to operate the keys on the operation panel.

About the built-in cooling fan

The inverter has a built-in cooling fan. The cooling fan has a useful life of approximately 30,000 hours (2 to 3 years when operated continuously), so it needs to be replaced periodically.

If the cooling fan does not operate normally, the temperatures of the internal electrical components will rise high, and as a result their lives will be shortened. So inspect it periodically.

■How to open the front and control circuit terminal (11kW – 75kW)

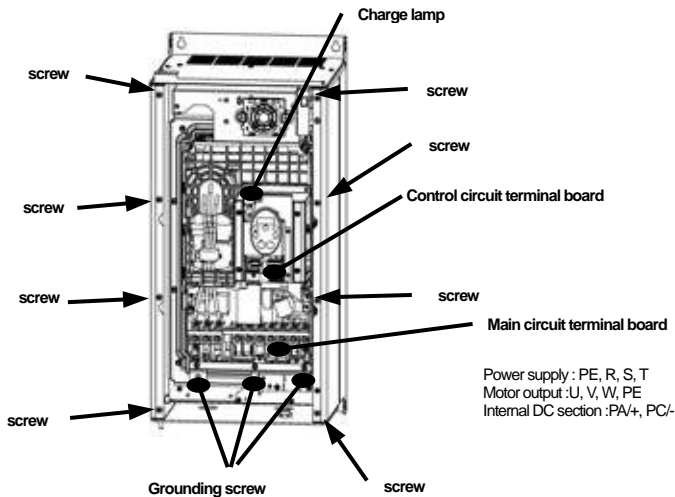

How to remove the front cover

1. Shut off the supply of electricity from the main power supply.
2. Ten minutes or more after turning off power, check to be sure that the CHARGE lamp is not lit.
3. Remove the 8 screws* (indicated by the arrows in the figure) around the front cover.
 (* 6 screws for 11kW-15kW models and smaller)

How to attach the front cover

1. Attach the front cover.
2. Set and tighten the 8 screws* (indicated by the arrows in the figure) around the front cover.
 (* 6 screws for 11kW-15kW models and smaller)

Caution: Attach the front cover securely.
 Or else it does not serve as a protector compliant with IP54.
 On top of that, it may become impossible to operate the keys on the operation panel.

About the built-in cooling fan

The inverter has a built-in cooling fan. The cooling fan has a useful life of approximately 30,000 hours (2 to 3 years when operated continuously), so it needs to be replaced periodically.
 If the cooling fan does not operate normally, the temperatures of the internal electrical components will rise high, and as a result their lives will be shortened. So inspect it periodically.

■Wiring diagram
0.75kW – 7.5kW

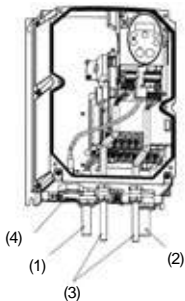

(PLE -type)

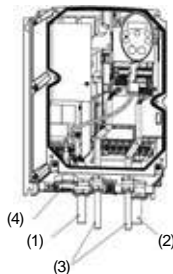

(PDE-type)

- (1) Input power cable
- (2) Output cable
- (3) Control cable
- (4) Optional communications device interconnect cable (option)

PLE, PL1E-type : EN61800-3, 1st Environment, C2(up to 5.5kW) or 2nd Environment , C3

PDE-type : EN61800-3, 1st Environment, C1

11kW – 18.5kW

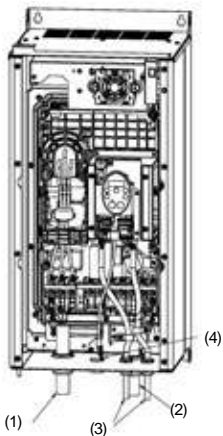

(PLE -type)

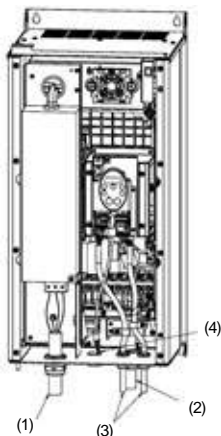

(PDE-type)

- (1) Input power cable
- (2) Output cable
- (3) Control cable
- (4) Optional communications device interconnect cable (option)

PLE-type : EN61800-3, 2nd Environment, C3

PDE-type : EN61800-3, 1st Environment, C1

22kW – 75kW

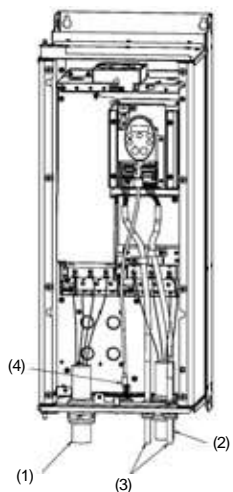

(PLE -type)

PLE-type : EN61800-3, 2nd Environment, C3

PDE-type : EN61800-3, 1st Environment, C1

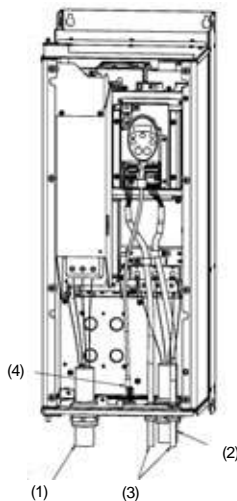

(PDE-type)

- (1) Input power cable
- (2) Output cable
- (3) Control cable
- (4) Optional communications device interconnect cable (option)

Caution

- Circuit boards are exposed when the front cover is removed. Since high voltages are applied to some parts of the circuit board, read Section 2.1, "Cautions on wiring," of the instruction manual E6581381 carefully before wiring. When connecting cables, take care not to damage the circuit board with a screwdriver or a similar tool.
- Never turn on the power ON-OFF switch before attaching the front cover. Or you could get a shock.
- In case of PDE-type, the input current flow the capacitor in the filter circuit. Therefore, the input current during the stopping the motor more than PLE-type and PL1E-type.
- If you want to disconnect the capacitor from the grounding line to reduce the amount of leakage current, you can do so easily using the switch or tap. Keep in mind, however, that disconnecting the capacitor from the grounding line causes the inverter to become non-compliant with the EMC directive. Also note that the inverter must always be turned off before the capacitor is disconnected or reconnected.
- The hole for optional communications device interconnect cable does not open (factory setting, 11.0kW-75.0kW). Therefore, please open the hole yourself.

■ Grounding capacitor disconnecting switch

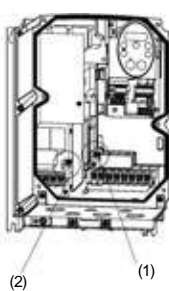

0.75kW-5.5kW

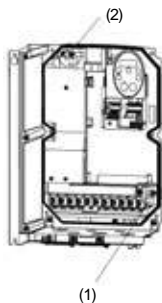

7.5kW

- (1) : Common with PLE and PDE
- (2) : Only PDE-type
- (3) : Only PLE-type

PLE, PL1E-type:EN61800-3,
1st Environment, C2 or 2nd Environment, C3
PDE-type:EN61800-3, 1st Environment, C1

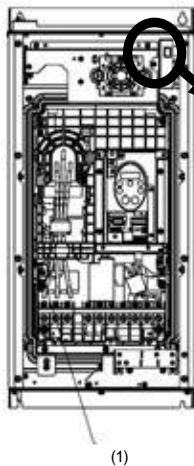

11kW-18.5kW

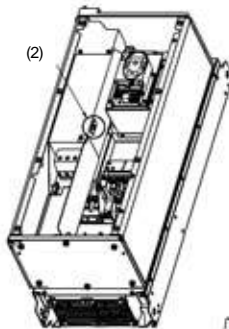
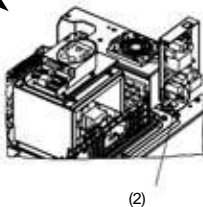

22kW-30kW

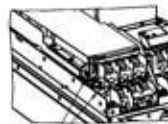

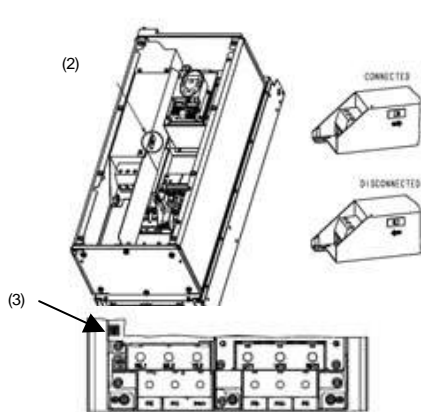

37kW-45kW

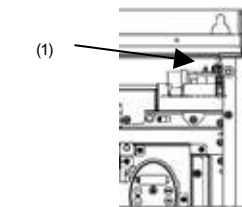

- (1) : Common with PLE and PDE
- (2) : Only PDE-type
- (3) : Only PLE-type

PLE-type:EN61800-3, 2nd Environment, C3
 PDE-type:EN61800-3, 1st Environment, C1

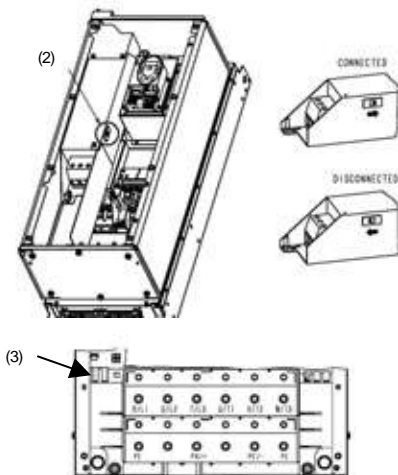

55kW-75kW

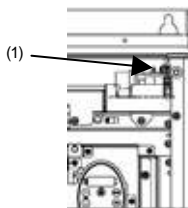

■ Measures to satisfy the EMC directive

Inverters are tested in this combination below.

	Transmission noise EN61800-3, 1st Environment, C2		Transmission noise EN61800-3, 2nd Environment, C3	
	Applicable filters	Length of motor connecting cable (m)	Applicable filters	Length of motor connecting cable (m)
VFFS1-4007PL1E	With a built-in filter	5	-	-
VFFS1-4015PL1E	With a built-in filter	5	-	-
VFFS1-4022PL1E	With a built-in filter	5	-	-
VFFS1-4037PL1E	With a built-in filter	5	-	-
VFFS1-4055PLE	With a built-in filter	5	-	-
VFFS1-4075PLE			With a built-in filter	5
VFFS1-4110PLE			With a built-in filter	5
VFFS1-4150PLE			With a built-in filter	5
VFFS1-4185PLE			With a built-in filter	5
VFFS1-4220PLE			With a built-in filter	5
VFFS1-4300PLE			With a built-in filter	5
VFFS1-4370PLE			With a built-in filter	20
VFFS1-4450PLE			With a built-in filter	20
VFFS1-4550PLE			With a built-in filter	100
VFFS1-4750PLE			With a built-in filter	100

	Transmission noise EN61800-3, 1st Environment, C1		Transmission noise EN61800-3, 1st Environment, C2	
	Applicable filters	Length of motor connecting cable (m)	Applicable filters	Length of motor connecting cable (m)
VFFS1-4007PDE	With a built-in filter	20	With a built-in filter	20
VFFS1-4015PDE	With a built-in filter	20	With a built-in filter	20
VFFS1-4022PDE	With a built-in filter	20	With a built-in filter	20
VFFS1-4037PDE	With a built-in filter	20	With a built-in filter	20
VFFS1-4055PDE	With a built-in filter	20	With a built-in filter	20
VFFS1-4075PDE	With a built-in filter	20	With a built-in filter	20
VFFS1-4110PDE	With a built-in filter	20	With a built-in filter	20
VFFS1-4150PDE	With a built-in filter	20	With a built-in filter	20
VFFS1-4185PDE	With a built-in filter	20	With a built-in filter	20
VFFS1-4220PDE	With a built-in filter	20	With a built-in filter	20
VFFS1-4300PDE	With a built-in filter	20	With a built-in filter	20
VFFS1-4370PDE	With a built-in filter	20	With a built-in filter	20
VFFS1-4450PDE	With a built-in filter	20	With a built-in filter	20
VFFS1-4550PDE	With a built-in filter	20	With a built-in filter	20
VFFS1-4750PDE	With a built-in filter	20	With a built-in filter	20

■ Outside dimensions

Applicable Motor (kW)	Inverter type	Mass (kg)	Outside dimensions (mm)						Outline	Cable port								
			W	H	D	W1	H1	D1										
0.75	VFFS1-4007PL1E	5.3	215	297	192.3	197	277	-	A	φ16.5×2 φ20.5×1 φ25.5×2								
	VFFS1-4007PDE	5.6																
1.5	VFFS1-4015PL1E	5.3																
	VFFS1-4015PDE	5.6																
2.2	VFFS1-4022PL1E	5.3																
	VFFS1-4022PDE	5.6																
3.7	VFFS1-4037PL1E	7.3	230	340	208.3	212	320	-	B	φ16.5×2 φ20.5×1 φ25.5×2								
	VFFS1-4037PDE	8.1																
5.5	VFFS1-4055PLE	7.2																
	VFFS1-4055PDE	8.1																
7.5	VFFS1-4075PLE	8.5																
	VFFS1-4075PDE	9.4																
11	VFFS1-4110PLE	21.0	295.3	560	292.9	250	544	6	C	φ16.5×1 φ25.5×1 φ32.5×1								
	VFFS1-4110PDE	25.5																
15	VFFS1-4150PLE	21.0																
	VFFS1-4150PDE	25.5																
18.5	VFFS1-4185PLE	28.5									315	665	293.4	270	647	6	D	φ16.5×1 φ32.5×2
	VFFS1-4185PDE	33.5																
22	VFFS1-4220PLE	29.0																
	VFFS1-4220PDE	33.5																
30	VFFS1-4300PLE	29.0	285	720	289.4	245	700	8	E	φ16.5×1 φ40.5×2								
	VFFS1-4300PDE	33.5																
37	VFFS1-4370PLE	38.1																
	VFFS1-4370PDE	43.5																
45	VFFS1-4450PLE	38.1									285	880	334	245	860	8	F	φ16.5×1 φ50.5×1 φ40.5×1
	VFFS1-4450PDE	43.5																
55	VFFS1-4550PLE	58.0																
	VFFS1-4550PDE	69.1																
75	VFFS1-4750PLE	58.0	362	1000	354	300	975	8	G	φ16.5×1 φ63.5×1 φ50.5×1								
	VFFS1-4750PDE	69.1																

(W: Width H: Height D: Depth W1: installation dimension(Width) H1: installation dimension(Height) D1: Depth1)

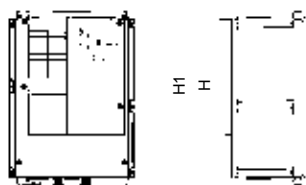

W1

W

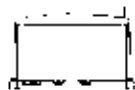

D

PL1E-type

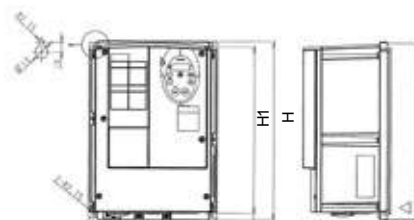

W1

W

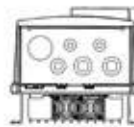

D

PDE-type

A

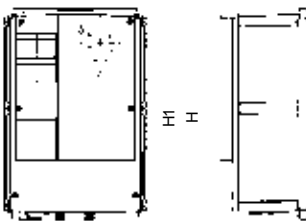

W1

W

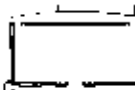

D

PL1E-type

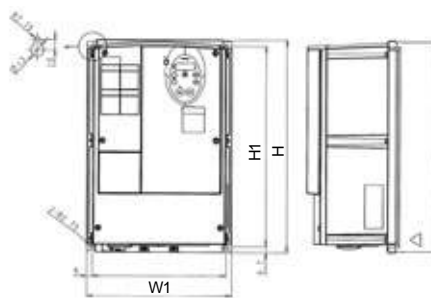

W1

W



D

PLE-type, PDE-type

B

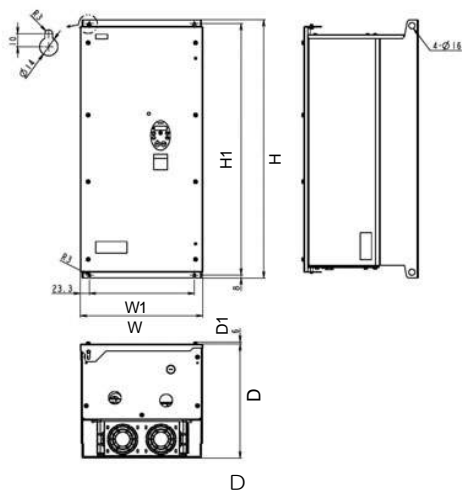
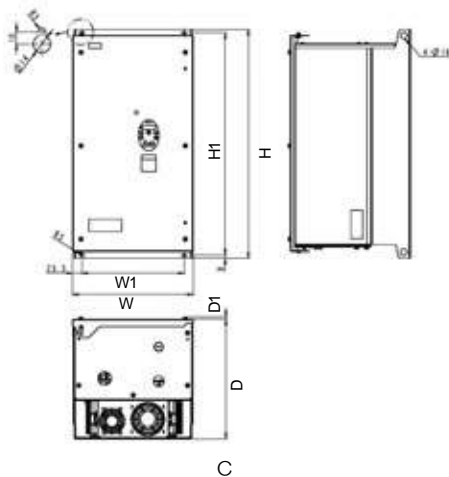

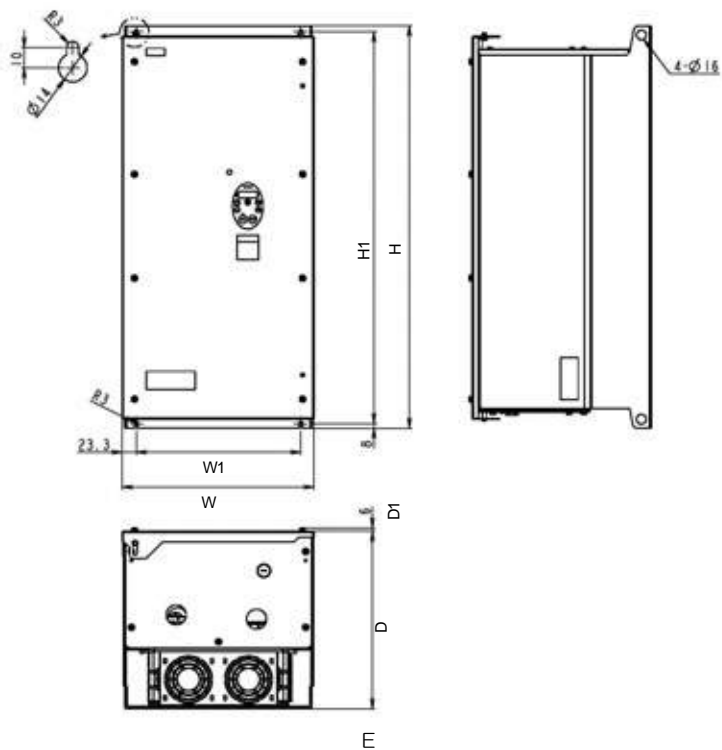

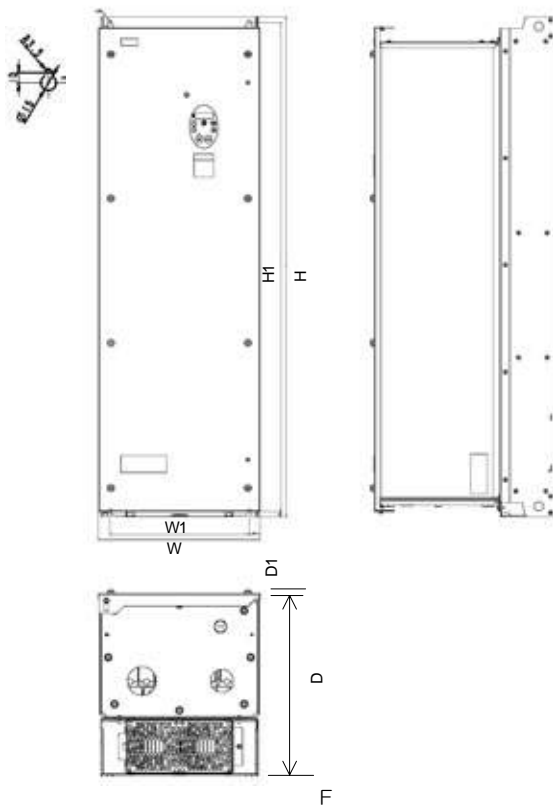

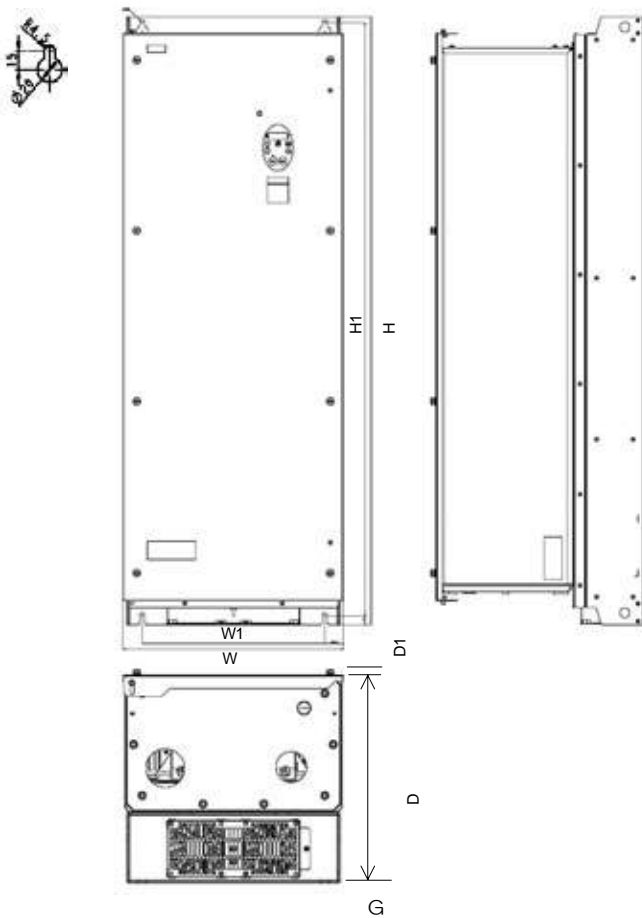

■ Specifications

Item			specification					
Voltage class			3-phase 400V class					
Applicable motor (kW)			0.75	1.5	2.2	3.7	5.5	7.5
Model	Voltage class	Model number	VFFS1-					
	3-phase 400V class	VFFS1-	4007PL1E 4007PDE	4015PL1E 4015PDE	4022PL1E 4022PDE	4037PL1E 4037PDE	4055PLE 4055PDE	4075PLE 4075PDE
Rating	Capacity (kVA)	Note 1:	1.6	2.8	3.9	6.9	9.1	12.2
	Output current (A)	Note 2: 3-phase 400V class	2.2	3.7	5.1	9.1	12.0	16.0
	Output voltage Note 3:		3-phase 380 to 480V					
Power supply	Overload current rating		110%-1min., 180%-2 sec. (50%-reduction value)					
	Voltage-frequency		3-phase 380 to 480V-50/60Hz					
	Allowable fluctuation		Voltage+10%, -15% Note 4, frequency±5%					
	Protective method		Totally enclosed type (JEM1030) compliant with IP54 Note 5:					
Cooling method			PL1E-type : Self-cooled				PLE-type : Forced air-cooled	
Color			Munsell 5Y-8/0.5					
Built-in filter			PLE, PL1E-type : EN61800-3, 1st Environment, C2 or 2nd Environment, C3 PDE-type : EN61800-3, 1st Environment, C1					
Environments	Use environments		Indoor type. Altitude: Not more than 1000m. Place free from corrosive and explosive gases					
	Ambient temperature		-10 to +50°C Note2					
	Storage temperature		-25 to +70°C					
	Relative humidity		20 to 93%					
	Vibration		5.9m/S ² or less (10 to 55Hz)					

Item			specification					
Voltage class			3-phase 400V class					
Applicable motor (kW)			11	15	18.5	22	30	37
Model	Voltage class	Model number	VFFS1-					
	3-phase 400V class	VFFS1-	4110PLE 4110PDE	4150PLE 4150PDE	4185PLE 4185PDE	4220PLE 4220PDE	4300PLE 4300PDE	4370PLE 4370PDE
Rating	Capacity (kVA)	Note 1:	17.1	23.2	28.2	33.2	44.6	52.0
	Output current (A)	3-phase 400V class	22.5	30.5	37.0 (33.3)	43.5 (39.2)	58.5 (52.7)	79.0 (71.1)
	Output voltage Note 3:		3-phase 380 to 480V					
	Overload current rating		110%-1min., 180%-2 sec. (50%-reduction value)					
Power supply	Voltage-frequency		3-phase 380 to 480V-50/60Hz					
	Allowable fluctuation		Voltage+10%, -15% Note 4.; frequency±5%					
	Protective method		Totally enclosed type (JEM1030) compliant with IP54 Note 5:					
Cooling method			Forced air-cooled					
Color			Munsel 5Y-8/0.5					
Built-in filter			PLE-type : EN61800-3, 2nd Environment, C3 PDE-type : EN61800-3, 1st Environment, C1					
Environments	Use environments		Indoor type. Altitude: Not more than 1000m. Place free from corrosive and explosive gases					
	Ambient temperature		-10 to +50°C Note2					
	Storage temperature		-25 to +70°C					
	Relative humidity		20 to 93%					
	Vibration		5.9m/S ² or less (10 to 55Hz)					

Item			specification					
Voltage class			3-phase 400V class					
Applicable motor (kW)			45	55	75	-	-	-
Model	Voltage class	Model number	VFFS1-					
	3-phase 400V class	VFFS1-	4450PLE 4750PDE	4550PLE 4550PDE	4750PLE 4750PDE	-	-	-
Rating	Capacity (kVA)	Note 1:	61.9	76.3	105.3	-	-	-
	Output current (A) Note 2:	3-phase 400V class	94.0 (75.2)	116.0 (104.4)	160.0 (128.0)	-	-	-
	Output voltage Note 3:	3-phase 380 to 480V						
	Overload current rating	110%-1min., 180%-2 sec. (50%-reduction value)						
Power supply	Voltage-frequency	3-phase 380 to 480V-50/60Hz						
	Allowable fluctuation	Voltage+10%, -15% Note 4; frequency±5%						
Protective method			Totally enclosed type (JEM1030) compliant with IP54 Note 5:					
Cooling method			Forced air-cooled					
Color			Munsel 5Y-8/0.5					
Built-in filter			PLE-type : EN61800-3, 2nd Environment, C3 PDE-type : EN61800-3, 1st Environment, C1					
Environments	Use environments	Indoor type. Altitude: Not more than 1000m. Place free from corrosive and explosive gases						
	Ambient temperature	-10 to +50°C Note2						
	Storage temperature	-25 to +70°C						
	Relative humidity	20 to 93%						
Vibration			5.9m/S ² or less (10 to 55Hz)					

Note1) Capacity is calculated at 440V for the 400V models.

Note2) The values between parentheses refer to output currents at PWM carrier frequencies of over 12kHz. When installing the inverter where the ambient temperature will rise above 40degree, use the inverter with the rated output reduced. If the PWM carrier frequency is modified is necessary to reduce output current. Refer to following figures. If a motor cable over 30m in length is used, it is necessary to reduce them more. This means that the lives of the internal components will be shortened

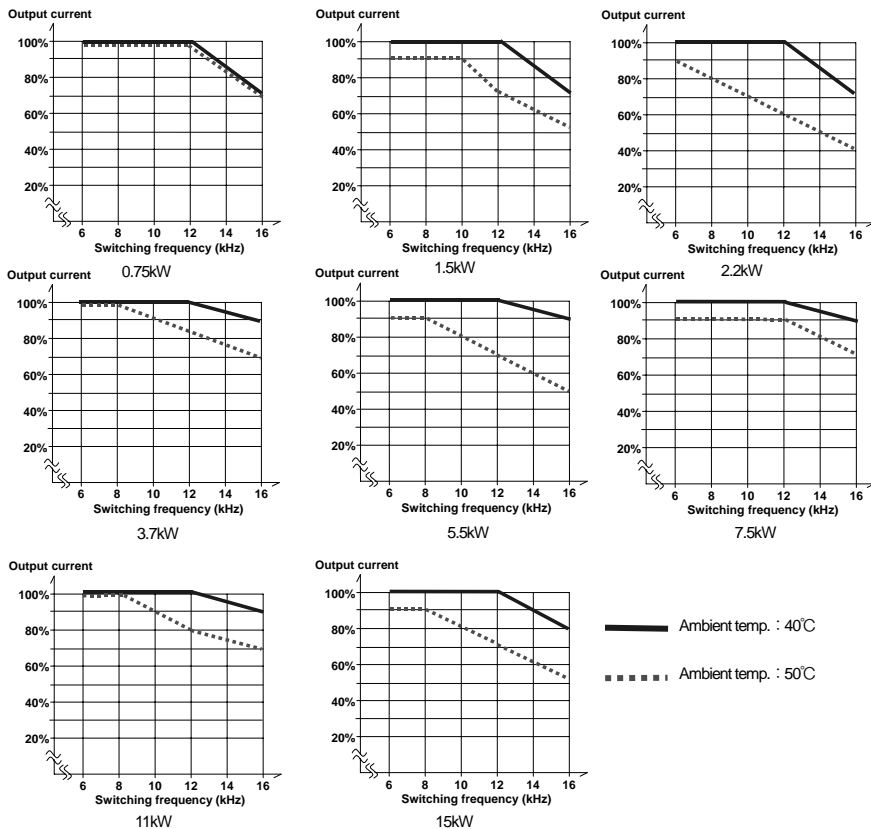

Output current

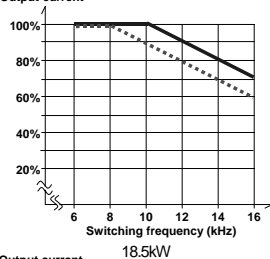

18.5kW

Output current

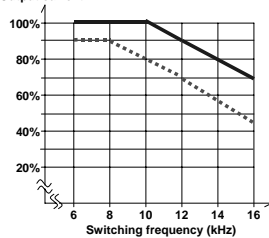

22kW

Output current

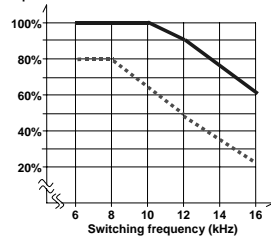

30kW

Output current

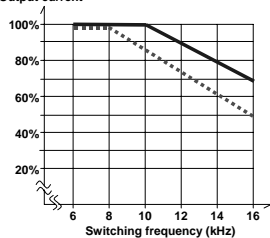

37kW

Output current

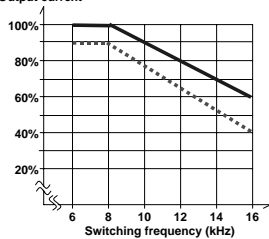

45kW

Output current

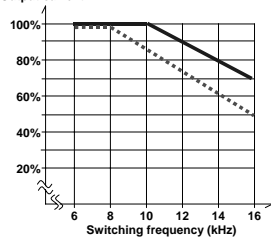

55kW

Output current

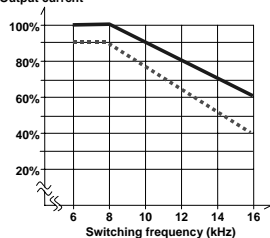

75kW

— Ambient temp. : 40°C

..... Ambient temp. : 50°C

Note3) The maximum output voltage is equal to the input supply voltage.

Note4) $\pm 10\%$ when the inverter is operated continuously (under a load of 100%).

Note5) IP54-compliant structures refer to structures that protect the contents from dust and harmful effects of water that drops from every direction.

Use PG screw type cable grounds among cable grounds available are skin-top grounds manufactured by LAPP (Germany).

When using this type of grounds, use them in combination with lock nuts specified below.

Cable port	Cable ground	Cable ground(EMC-compliant)	Lock nut
Φ16.5 hole	MS-M16X1.5	MS-SC-M16X1.5	SM-M16X1.5
Φ20.5 hole	MS-M20X1.5	MS-SC-M20X1.5	SM-M20X1.5
Φ25.5 hole	MS-M25X1.5	MS-SC-M25X1.5	SM-M25X1.5
Φ32.5 hole	MS-M32X1.5	MS-SC-M32X1.5	SM-M32X1.5
Φ40.5 hole	MS-M40X1.5	MS-SC-M40X1.5	SM-M40X1.5
Φ50.5 hole	MS-M50X1.5	MS-SC-M50X1.5	SM-M50X1.5
Φ63.5 hole	MS-M60X1.5	MS-SC-M60X1.5	SM-M60X1.5

Note6) For control specifications, parameters and functions, refer to the instruction manual E6581381.

Note7) The inverter has a built-in cooling fan. The cooling fan has a useful life of approximately 30,000 hours (2 to 3 years when operated continuously), so it needs to be replaced periodically.

If the cooling fan does not operate normally, the temperatures of the internal electrical components will rise high, and as a result their lives will be shortened. So inspect it periodically.