

TOSHIBA

Instruction Manual

Totally enclosed box type Inverter

TOSVERT™ VF-PS1



NOTICE

1. Make sure that this instruction manual is delivered to the end user of the inverter unit.
2. This manual gives supplementary information of some items referred in the instruction manual E6581386 supplied with the product. Read this manual and E6581386 before installing or operating the inverter unit, and store them in a safe place for reference.

Safety precautions

I

Introduction

II

Contents

Read first

1

Connection of equipment

2

Operations

3

Searching and setting parameters

4

Monitoring the operation status

5

List of function key functions

6

Measures to satisfy the standards

7

Selection of peripheral devices

8

Table of parameters

9



Specifications

10

I. Safety precautions

Thoroughly familiarize yourself with the symbols and indications shown in "I. Safety Precautions," of the instruction manual E6581386 and below, and then continue to read manuals. Make sure that you observe all cautions given.

■ Transportation & installation

 <h2 style="display: inline;">Caution</h2>	
 Mandatory	<ul style="list-style-type: none"> • Handle the inverter unit with a crane. Lifting heavy inverters can cause injury to persons. Taking care of safety for users, handle carefully in order not to damage the inverter. Carefully lift up the inverter, hanging wires on the hanging bolts or holes on the top or bottom of the inverter. <div style="text-align: center; margin: 20px 0;">  </div> <p>Note 1: Always keep the two sling ropes in balance when lifting the inverter, and take care that unexpected force does not apply to the inverter during lifting.</p> <p>Note 2: Always protect the inverter with a cover when transporting it.</p> <p>Note 3: Do not put your hand in the wiring port or do not hold it when transporting the inverter.</p> <ul style="list-style-type: none"> • The main unit must be installed on a base that can bear the unit's weight. If the unit is installed on a base that cannot withstand that weight, the unit may fall resulting in injury. • Install a mechanical brake whenever the motor requires a brake (device which retains the motor shaft). Failure to do so could lead to injury to persons because the inverter itself has no function of mechanically retaining the brake shaft.

II. Introduction

Thank you for your purchase of the totally enclosed box type for IP54 Inverter, "TOSVERT VF-PS1".

Note) Drives with UL Type 12 conformity are optional. Contact your nearest Toshiba inverter distributor for them.

II

- Contents -

I. Safety precautions	1
II. Introduction	2
1. Read first	A-1
1.1 Check the product	A-1
1.2 Contents of the product code	A-1
1.3 Structure of the main body	A-2
1.3.1 Names and functions	A-2
1.3.2 Detaching the cover	A-11
1.3.3 Grounding capacitor switching method	A-12
1.3.4 In case of adopting external braking resistor (Optional)	A-13
1.4 Notes on the application	A-14
1.4.1 Installation	A-14
2. Connection of equipment	B-1
2.1 Cautions on wiring	B-1
2.2 Standard connections	B-2
2.3 Description of terminals	B-3
2.3.1 Main circuit terminals	B-3
3. Operations	C-1
3.1 Settings to be made at first power on	C-1
3.2 Setting/monitor modes	C-2
3.3 Operation in Top View Mode	C-3
3.3.1 Setting a panel operation frequency	C-3
3.3.2 Using an EASY key function	C-4
3.3.3 Selecting a language to be displayed	C-5
3.3.4 Performing jog run	C-5
3.3.5 Emergency stop / reset operation	C-6
4. Searching and setting parameters	D-1
4.1 Searching for the change histories of parameters (History function)	D-1
4.2 Setting a basic parameter	D-2
4.3 Setting an extended parameter	D-3
4.4 Searching for parameters whose setting has been changed (Changed Parameters)	D-4
5. Monitoring the operation status	E-1
5.1 Displaying details of an item monitored	E-2
6. List of function key functions	F-1
7. Measures to satisfy the standards	G-1
7.1 How to cope with the CE standard	G-1
7.1.1 Measures to satisfy the EMC directive	G-1
7.2 Measures to be taken to satisfy the UL/CSA standards	G-4
7.2.1 Cautions as to peripheral devices	G-4
7.2.2 Conforming to UL Type 12	G-4
8. Selection of peripheral devices	H-1
8.1 Selection of wiring materials and devices	H-1
9. Table of parameters	I-1
10. Specifications	J-1
10.1 Models and their standard specifications	J-1
10.2 Outside dimensions and weights	J-4

1. Read first

1.1 Check the product

Type indication

VF-PS1 3PH-200/240V
0.75kW/1HP

Series name
Power supply
Motor capacity

Inverter main unit

Type indication
Warning label

Name plate

Applicable motor
Invert rated output capacity
Power supply
Related input current
Related output current
Serial No.

Carton box

Type indication label

Operation panel

*1)

Instruction manuals (2 volumes)

This manual E6581386

Warning label

*1): Operation panel is not attached to the inverter main unit at the delivery. Refer to 1.3.1 and attach the panel to the unit before installing the inverter.

1.2 Contents of the product code

Explanation of the type and form written on the label.

Type		Form					Special specification code						
V F P S 1		4	0	0	7	P	L	E	W	N	A	2	2
Model name	Voltage class	Applicable motor capacity		Operation panel	Additional functions I	Additional functions II	Special specification code						
TOSVERT VF-PS1 series	4: 380V~480V	004:0.4kW 007:0.75kW 015:1.5kW 022:2.2kW 037:3.7kW 055:5.5kW 075:7.5kW 110:11kW 150:15kW	185:18.5kW 220:22kW 300:30kW 370:37kW 450:45kW 550:55kW 750:75kW 900:90kW	P: Provided	L: Built-in EMC filter (class A) + basic filter D: Built-in EMC filter (class B) + basic filter	E: Totally enclosed box type Y: Others (non-standard)	A□□: Special specification code (□ is a number)						
											Default interface logic (*1)		
											WN: Negative WP: Positive		

*1): This code represents the factory default logic setting. You can switch from one input/output logic to the other using slide switch SW1. ⇒For more details, refer to the manual E6581386 Section 2.3.2.

1.3 Structure of the main body

1.3.1 Names and functions

1) Outside view

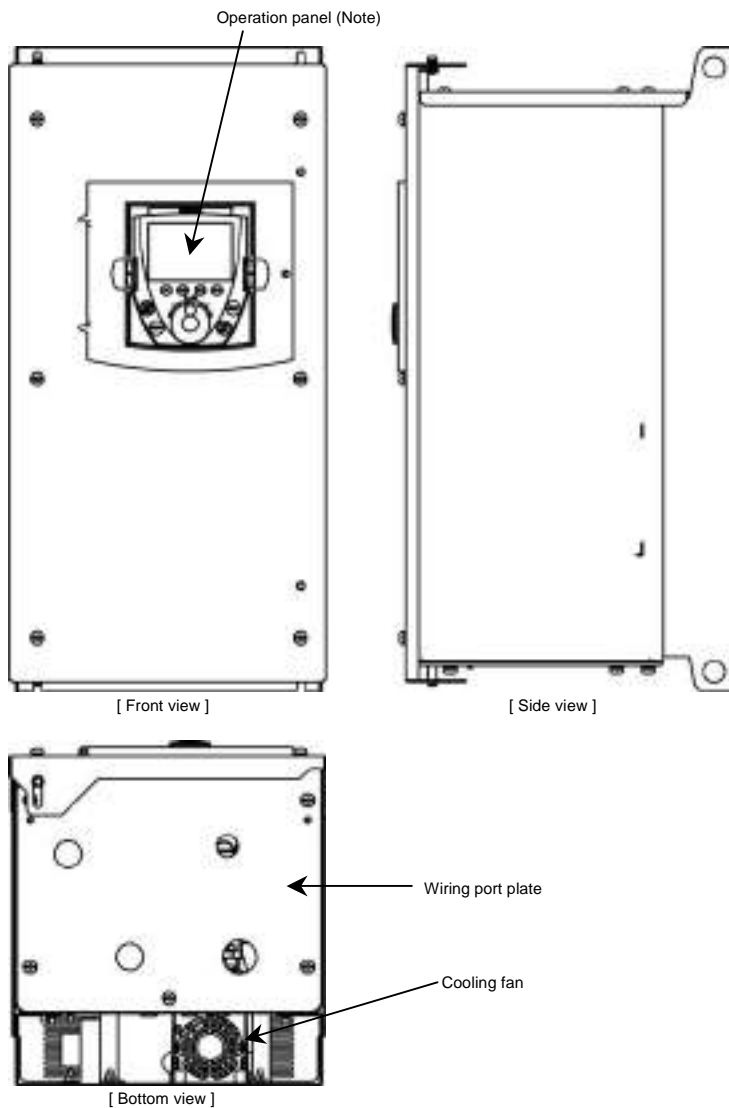

Note: Operation panel is not attached to the inverter main unit at the delivery. Attach the panel at the position of the upper figure before installing the inverter.

■ **Operation panel**

Totally enclosed box type VF-PS1 series have a special operation panel.

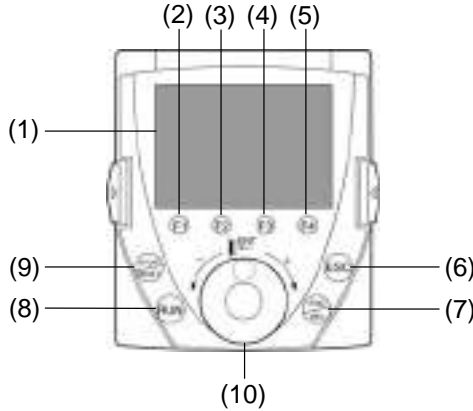

(1): LCD panel

For explanation of windows displayed, see the next page.

(2) to (5): [F1] to [F4] function keys

The function of each function key varies depending on the window currently displayed.

⇒ Refer to the next page and "6. List of function key functions"

(6): [ESC] key

Each time this key is pressed, modes change from one to another. Also, pressing this key brings you back to the window one level higher in the window hierarchy.

(7): [FWD/REV] key

Each time this key is pressed, the direction of operation changes between forward run and reverse run.

(To use this key, parameter settings need to be changed. ⇒ Refer to the next page.)

(8): [RUN] key

The drive starts operation.

(To use this key, parameter settings need to be changed. ⇒ Refer to the next page.)

(9): [STOP/RESET] key

The drive stops operation.

(To use this key, parameter settings need to be changed. ⇒ Refer to the next page.)

In case the inverter has tripped, pressing this key twice in a row resets the inverter.

* If multiple commands are entered by pressing the three keys [F2], [F3] and [F4] or [ESC], [FWD] and [RUN] in rapid succession, a stop command will be issued instead to stop operation.

(10): Control dial

In a menu window, turn the dial clockwise or counterclockwise to select a menu item (the item selected is highlighted) and press the dial to confirm the menu item selected.

Turn the dial clockwise (+) to select an item that follows the item currently selected.

Turn the dial counterclockwise (-) to select an item that precedes the item currently selected.

Selecting a menu item by turning the dial clockwise or counterclockwise and confirm the item selected by pressing the dial are referred to as "select/confirm an item."

In a value setting window, turn the dial clockwise or counterclockwise to increment or decrement the value displayed, and press the dial to confirm the value specified.*1

Turn the dial clockwise (+) to increment the value.

Turn the dial counterclockwise (-) to decrement the value.

Turning the dial clockwise or counterclockwise to increment or decrement the value displayed and pressing the dial to confirm the value specified are referred to as "specify/confirm a value."

*1: Some settings are executed only by tuning the control dial.

■ LCD panel

This section explains the features of windows available, using the top window of Status Monitor Mode as an example.

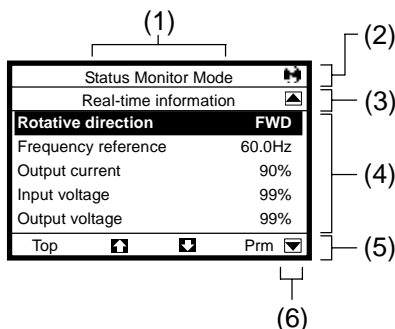

(1): Displays the mode currently selected.

(2): Displays the operating status of the inverter with a graphical symbol.

- (Rotating) : In operation
- : Operation impossible (While the frequency is set at 0Hz, the [RUN] key is pressed.)
- (blinking) : Waiting for emergency stop operation

(3): Displays the title or status of the window.

(4): Displays settings both in a menu form and numerically, or a list of various kinds of information.

(5): Displays the function assigned to each function key in an abbreviation or graphical symbol. The abbreviations and graphical symbols in the window correspond to the [F1] to [F4] keys, respectively starting from the left.

- Top : In this example, pressing the [F1] key displays the Top View Mode window.
 - : In this example, pressing the [F2] key displays the previous window.
 - : In this example, pressing the [F3] key displays the next window.
 - Prm : In this example, pressing the [F4] key displays the Parameter Setting Mode window.
- ⇒ For details, refer to "5. List of function key functions".

(6) Graphical symbols displayed vary depending on whether there are windows that precede or follow the current window.

- : There are windows that precede and/or follow the current window.
- : There is no window that precedes or follows the current window.

■ About changing parameter settings

By default, the inverter is set with parameters to the mode in which it controls the operation of the machine via a terminal board. Moreover, the inverter is set so that the switching between forward run and reverse run cannot be performed using its operation panel.

To operate the inverter using this unit, parameter settings need to be changed, as described below.

- Parameter CMOD (Command input mode) = 1 (Pane/LCD-option)
- Parameter FMOd (Frequency input mode 1) = 4 (Pane/LCD-option)
- Parameter Fr (Panel FWD/REV selection) = 2 (Forward (switchable)),
3 (Reverse (switchable))

This change of parameter settings makes it possible to start operation using the [RUN] key, to stop operation using the [STOP/RESET] key, and to switch between forward run and reverse run using the [FWD/REV] key.

Furthermore, it allows you to set an operation frequency using the control dial.

⇒ Refer to "3.3.1 Setting a panel operation frequency."

2) Main circuit terminal

VFPS1-4007PLE-4022PLE

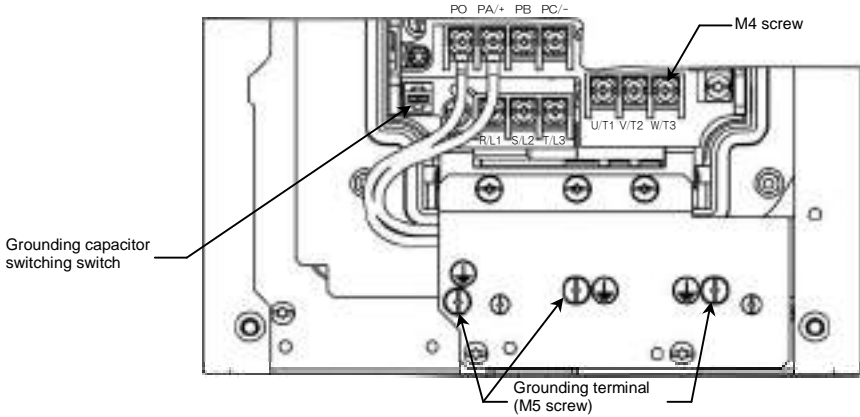

1

VFPS1-4007PDE-4022PDE

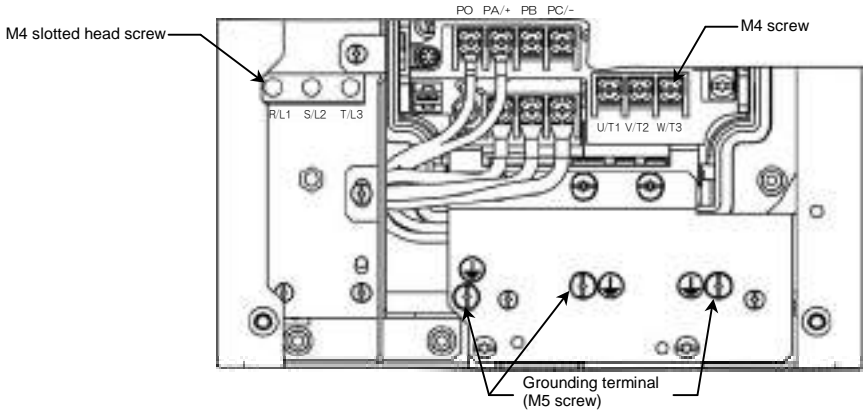

VFPS1-4037PLE, 4055PLE

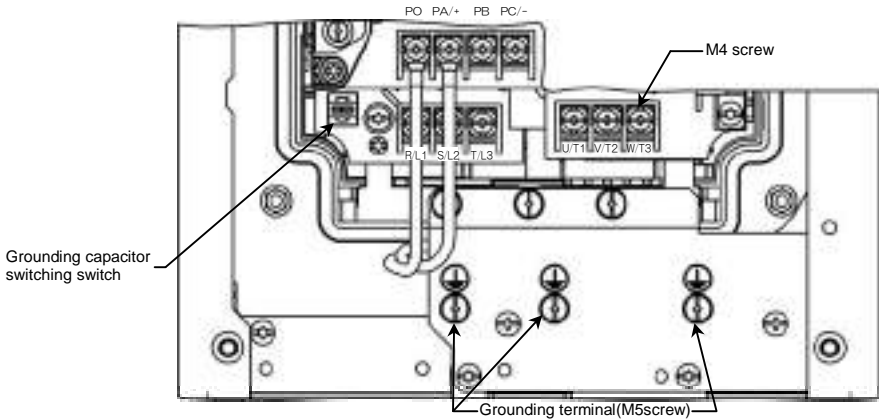

VFPS1-4037PDE, 4055PDE

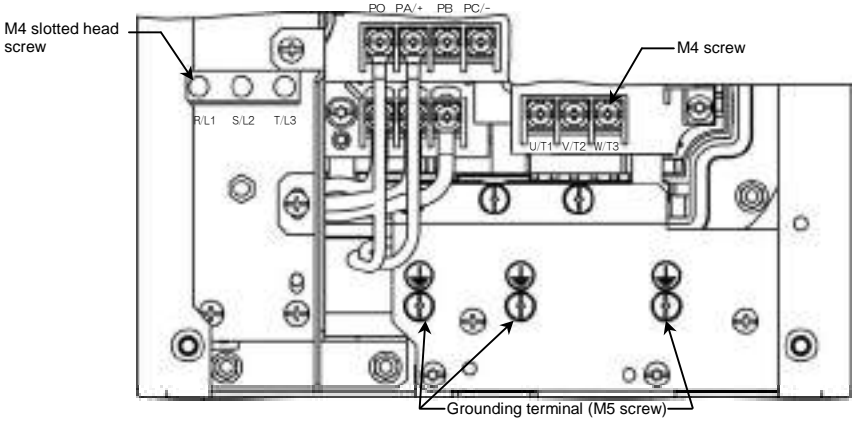

VFPS1-4075PLE, 4110PLE

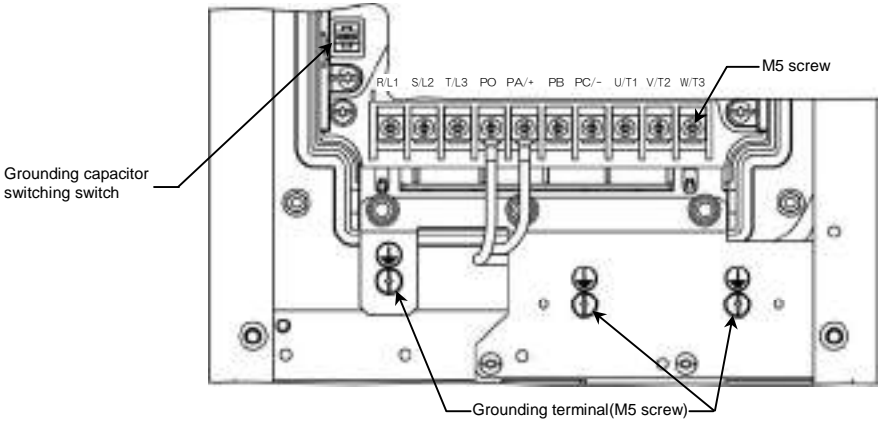

VFPS1-4075PDE, 4110PDE

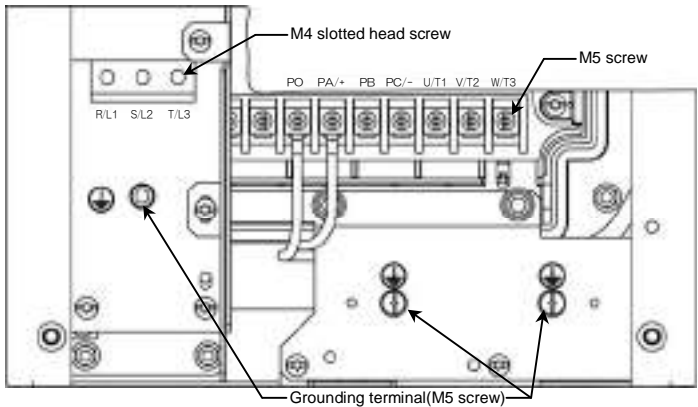

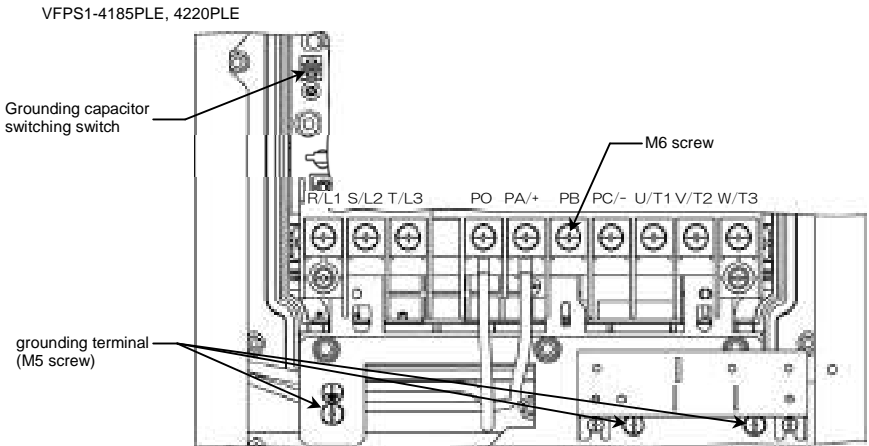
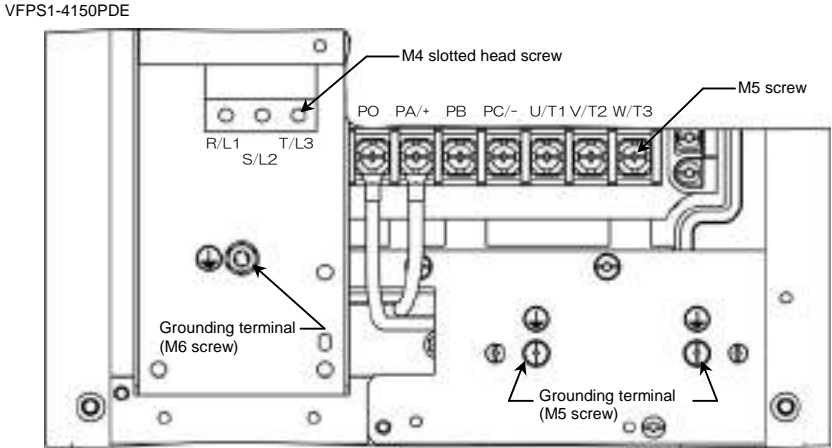
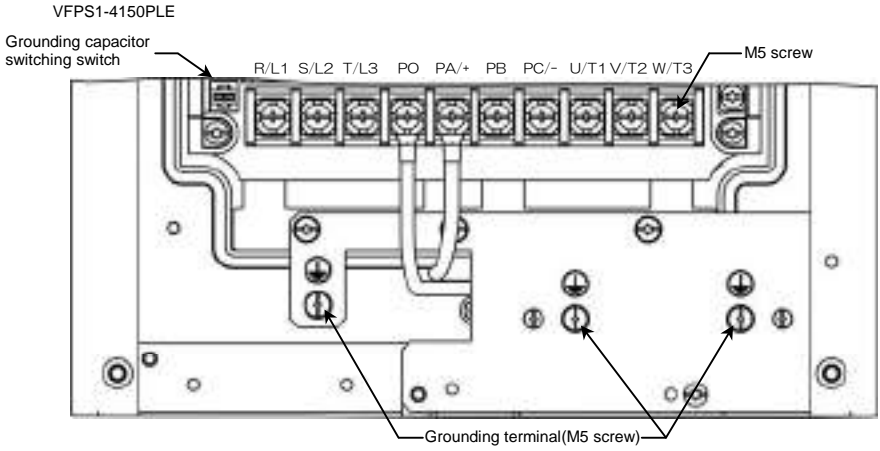

1

VFPS1-4185PDE, 4220PDE

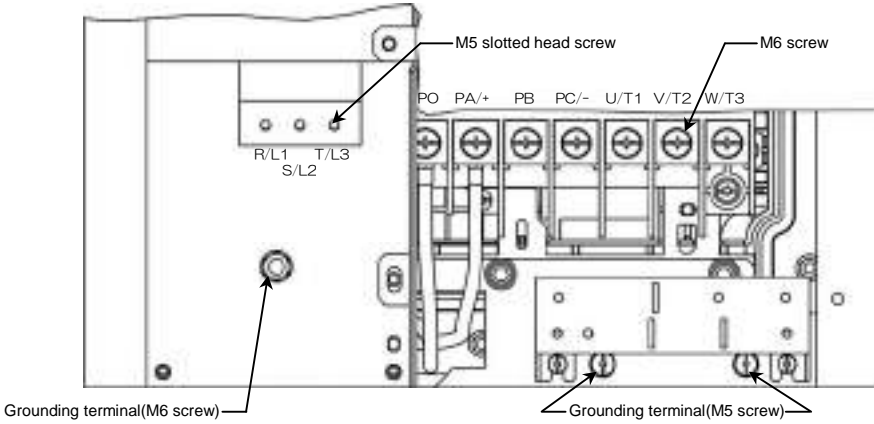

VFPS1-4300PLE

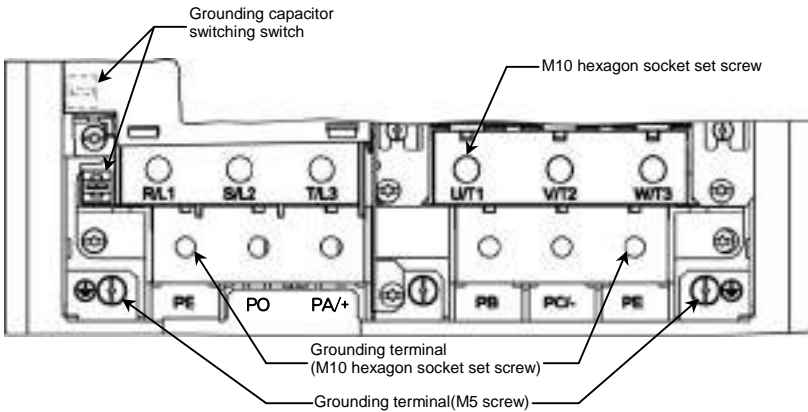

VFPS1-4300PDE

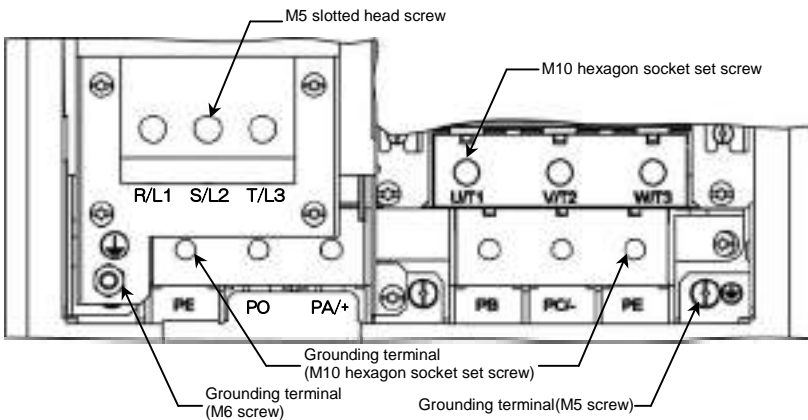

VFPS1-4370PLE, 4450PLE

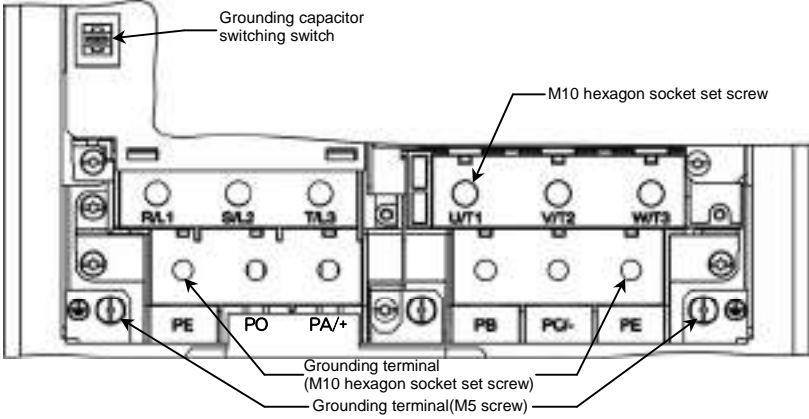

VFPS1-4370PDE, 4450PDE

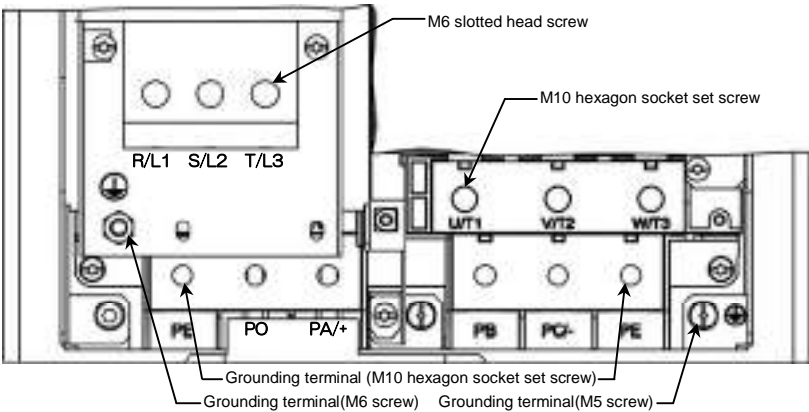

VFPS1-4550PLE-4900PLE

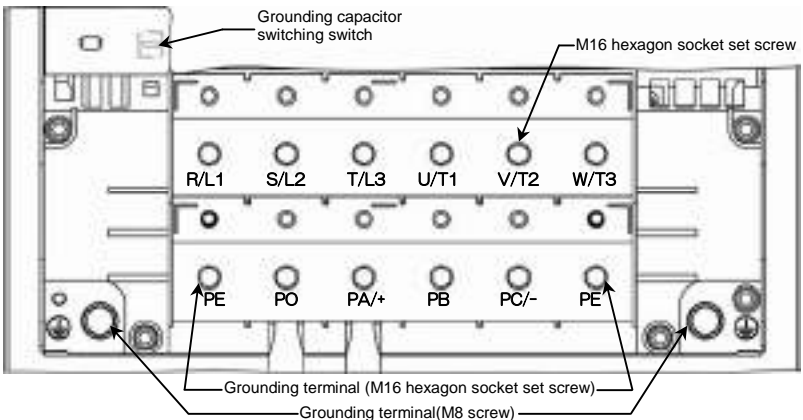

1

VFPS1-4550PDE~4900PDE

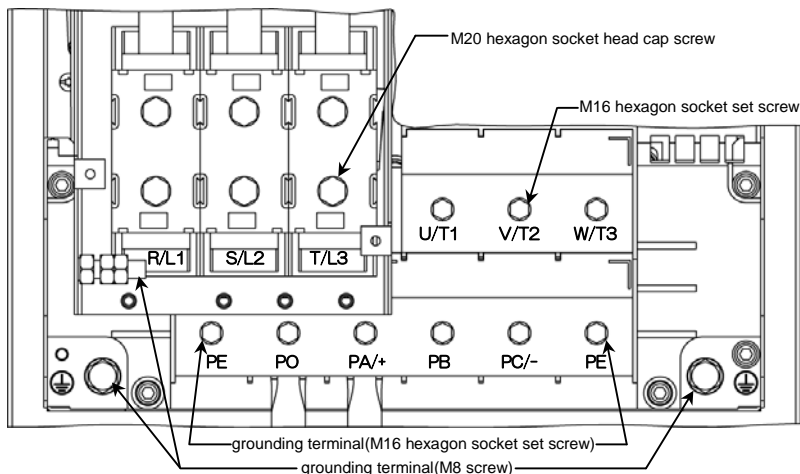

Following power terminals are cage type ones.

- Input terminals of VFPS1-4007PDE to 4220PDE

- All power terminals of VFPS1-4300PLE to 4900PLE, VFPS1-4300PDE to 4900PDE

For tightening torque and cable stripping length, refer to the table below.



Type VFPS1-	Input terminals R/L1, S/L2, T/L3			DC terminals and Output terminals PO, PA/+, PB, PC/-, U/T1, V/T2, W/T3			Grounding terminals *1)		
	Tightening torque		Stripping length mm	Tightening torque		Stripping length mm	Tightening torque		Stripping length mm
	N-m	lb-ins		N-m	lb-ins		N-m	lb-ins	
4300PLE	24	212	22	24	212	22	24	212	22
4370PLE, 4450PLE	24	212	22	24	212	22	24	212	22
4550PLE~4900PLE	41	360	34	41	360	34	41	360	34
4007PDE~4022PDE	0.7	6.3	8	-	-	-	-	-	-
4037PDE, 4055PDE	0.7	6.3	8	-	-	-	-	-	-
4075PDE, 4110PDE	1.7	15.2	9	-	-	-	-	-	-
4150PDE	1.7	15.2	11	-	-	-	-	-	-
4185PDE, 4220PDE	2.2	19.6	16	-	-	-	-	-	-
4300PDE	4.3	38.4	19	24	212	22	24	212	22
4370PDE, 4450PDE	7	62.6	24	24	212	22	24	212	22
4550PDE~4900PDE	25	221	27	41	360	34	41	360	34

*1) For 4300PLE to 4900PLE and 4300PDE to 4900PDE, these values are for PE terminals (cage type ones).

Refer to following table for tightening torque for other grounding terminals.

Recommended tightening torque for power terminal screws		
	N-m	lb-ins
M 3	0.6	5.3
M 4	1.4	12.4
M 5	3.0	26.6
M 6	5.4	47.8
M 8	12.0	106
M10	24.0	212
M12	41.0	360

1.3.2 Detaching the cover

 Danger	
 Mandatory	<ul style="list-style-type: none"> • Never remove the front cover while power is on or within 15 minutes after power off. Never turn on the power while the front cover is open. Circuit boards are exposed when the front cover is removed and contact with them will result in electric shock. • The following steps must be performed before wiring. <ol style="list-style-type: none"> (1) Turn off all input power to the inverter. (2) Wait at least 15 minutes, and remove screws on front cover and open the front cover. In this step, take care not to touch inside the inverter drive. (3) Check that the charge lamp is no longer lit, and remove the front cover. (4) Use a tester that can measure DC voltage 800VDC or more, and check to make sure that the voltage to the DC main circuits (between PA/+ and PC/-) is 45V or less. If these steps are not properly performed, the wiring will cause electric shock.

1

■ Front cover

Before removing the front cover in order to wire for power terminals or control terminals, detach the cable for operation panel as shown below.

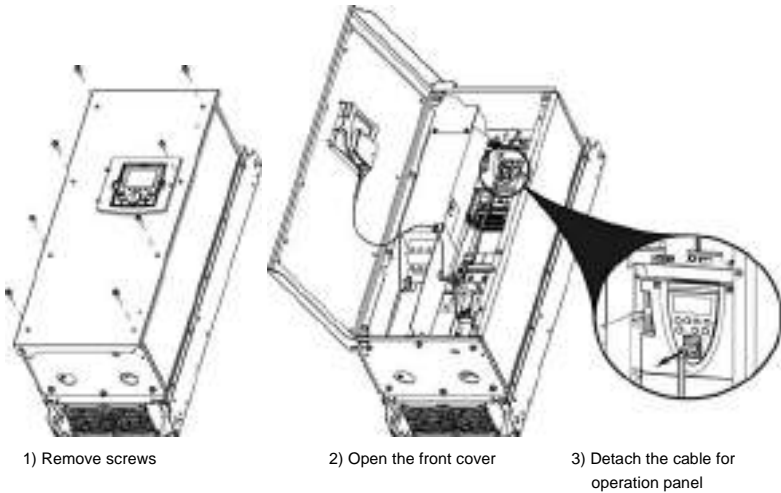

After wiring, connect the cable for operation panel to its original location before closing front cover.

Note) Attach the front cover correctly. Imperfect attachment may result in failure of IP54 compliance.

■ Charge lamp

Charge lamp is inside the unit front cover open. Never remove the front cover while power is on or within 15 minutes after power off, nor turn on the power while the front cover is open. They can result in electric shock. Location of charge lamp depends on type form.

VFPS1-4007PLE~4220PLE
VFPS1-4007PDE~4220PDE

VFPS1-4300PLE~4900PLE
VFPS1-4300PDE~4900PDE

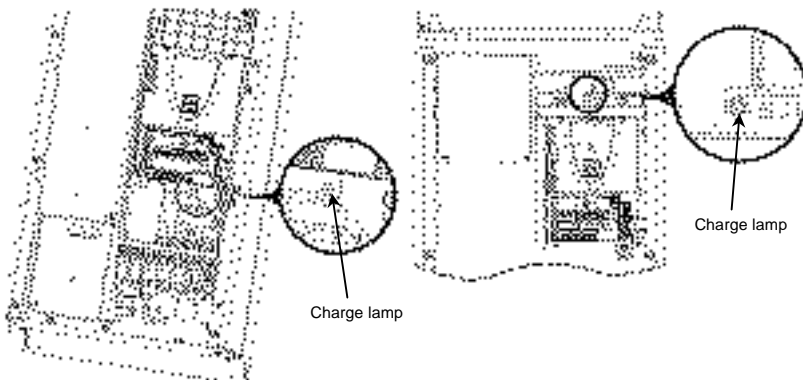

1

1.3.3 Grounding capacitor switching method

The inverter is grounded through a capacitor. The leakage current from the inverter can be reduced using the switching switch on the main circuit terminal board. This switching device is used to detach the capacitor from the grounding circuit or to reduce its capacitance.

Some models have capacitors that can be detached completely, while others have capacitors whose capacitances can be reduced.



VFPS1-4007PDE to 4220PDE don't have this switch.

Note 1: Please note that, without the capacitor, the inverter does not comply with the EMC directive.

With default setting, PLE type drives comply with EN55011 class A, and PDE type drives comply with EN55011 class B. For detailed information, refer to 7.1.1.

Note 2: When attaching or detaching the capacitor, be sure to turn off power.

■ VFPS1-4007PLE~4220PLE

 Danger	
 Prohibited	If you are using one of VFPS1-4007PLE~4055PLE inverter, or one of 4075PLE~4220PLE inverter with the cable between inverter to the motor which length is 100m or more, in case of detaching the grounding capacitor, be sure to set the carrier frequency (CF) at 4kHz or less. If the carrier frequency is set above 4kHz, internal parts of the inverter may overheat and be damaged.

A switch enables to detach the grounding capacitor. However, if you are using one of VFPS1-4007PLE~4055PLE inverter, or one of 4075PLE~4220PLE inverter with the cable between inverter to the motor which length is 100m or more, detaching the grounding capacitor must be followed with setting the carrier frequency (CF) at 4kHz or less. Be sure to read the above precaution.

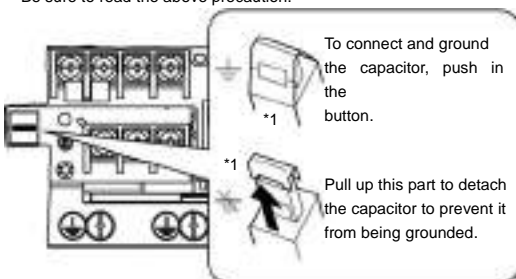

*1: For 4007PLE~4055PLE inverter, the switch is fixed with a label saying "CF/SFr ≤ 4kHz". If such a label is affixed to your inverter, you should set the carrier frequency (CF) at 4kHz or less according to the instructions when switching.

■ **VFPS1-4300PLE-4900PLE**

A switch or switches enable to reduce grounding capacitance.

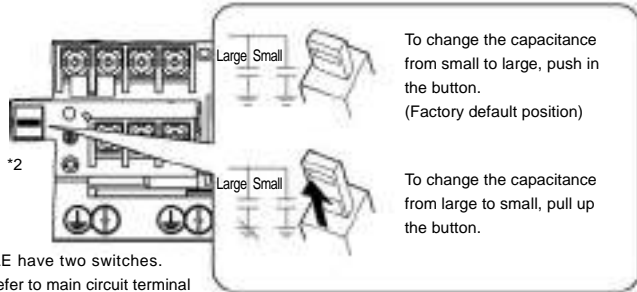

■ **VFPS1-4007PDE-4220PDE**

There is no switch.

■ **VFPS1-4300PDE-4900PDE**

A switch enables to reduce grounding capacitance.

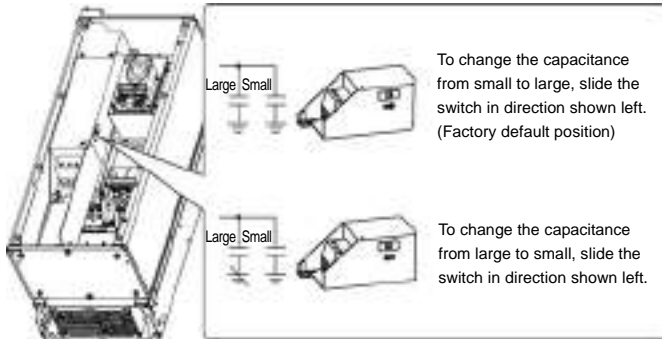

1.3.4 In case of adopting external braking resistor (Optional)

To wire for external braking resistor, an attention is needed because PA/+ terminal have a wiring to the internal DC reactor. Refer to followings when you wire for external braking resistor.

■ **0.75-22kW**

With reference of the figure right, make the each solderless terminal in back to back and fasten them with the screw.

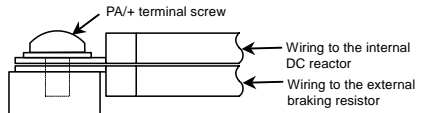

■ **30-90kW**

Fasten with the screw both of copper bar connected to the PA/+ terminal and the stripped cable for external braking resistor.

1.4 Notes on the application

1.4.1 Installation

■ Installation environment

- Operate in areas where ambient temperature ranges from -10°C to 50°C .
Where ambient temperature will rise above 40°C , derating of rated current is needed.
- Install the inverter in a well-ventilated place and mount it on a flat metal plate in portrait operation.
- Leave a space of 10cm or more on the upper and lower sides of the inverter, and a space of 5cm or more on each side.
- This inverter have a structure with IP54 conformity.
IP54 is a structure that protects the contents from dust and harmful effects of water that drops from every direction.

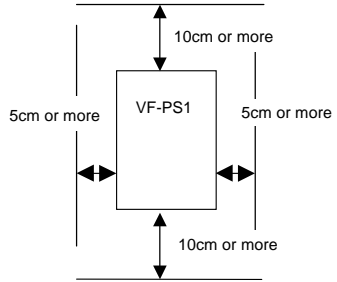

■ How to install

■ Derating curves

Derating curves in E6581386 manual are only for standard models. For totally enclosed box type, refer to following derating curves.

0.75~2.2, 30kW

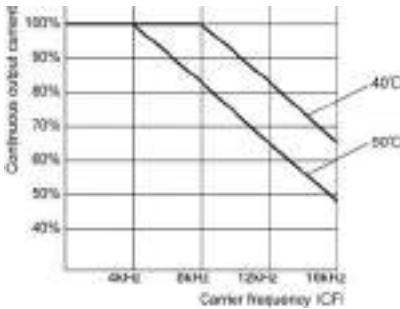

3.7, 5.5kW

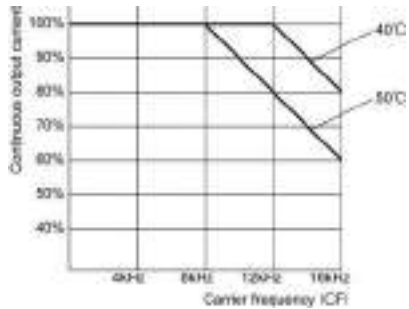

7.5, 11kW

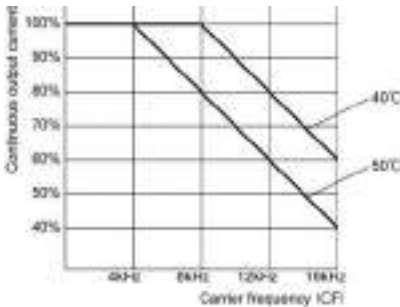

15~22, 37~90kW

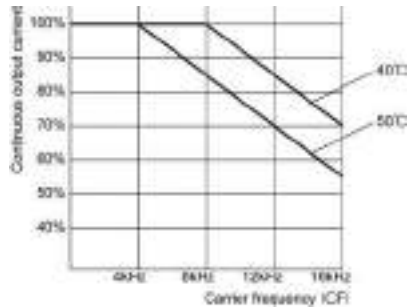

2. Connection of equipment

2.1 Cautions on wiring

■Wiring

- Following power terminals are cage type ones.
 - Input terminals of VFPS1-4007PDE to 4220PDE
 - All power terminals of VFPS1-4300PLE to 4900PLE, VFPS1-4300PDE to 4900PDE
 For tightening torque and cable stripping length, refer to 1.3.1 2).
- For power terminal other than above, use sleeved pressure terminal to connect. This is because the space between terminals is small. Connect sleeved pressure terminals so that adjacent terminals do not touch each other.
- For ground terminal, use wires of the size that is equivalent to or larger than those given in table below and always ground the inverter.

Use as large as and short a ground wire as possible and wire it as close as possible to the inverter.

Voltage class	Applicable Motor	Grounding wire size (AWG) [Note]	Grounding wire size (mm ²) [Note]
400V	0.75~7.5kW	14	2.5
	11kW	12	4
	15, 18.5kW	10	6
	22kW	10	10
	30~45kW	4	16
	55, 75kW	2	35
	90kW	2	50

Note1: The recommended cable size is that of the cable (e.g. 600V class, HIV cable) with continuous maximum permissible temperature of 75°C. The ambient temperature is assumed to be 40°C or below. (The interconnect cable length is assumed to be 30m or less.)

2

2.2 Standard connections

[Standard connection diagram – sink logic]

The figure below shows an example of typical wiring in the main circuit 200V 0.4-45kW/400V 0.75-75kW inverter. This inverter has following three setting/monitor modes.

Main circuit power source

400V class;
0.75-75kW Three-phase 380-480V-50/60Hz

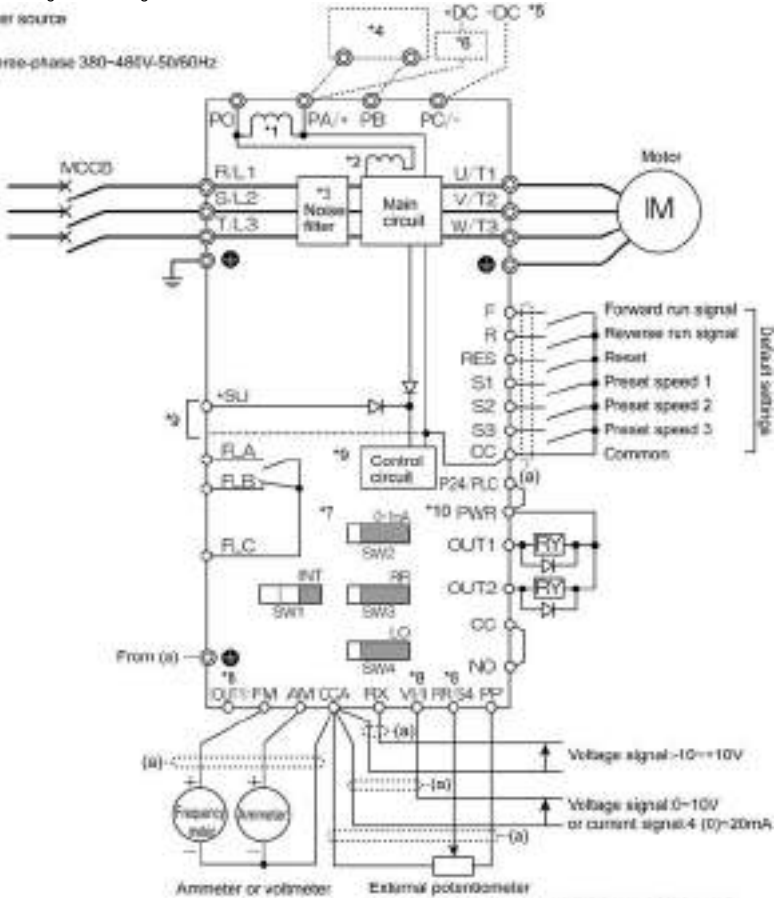

*1: A DC reactor (DCL) is incorporated in the position shown the figure above. External DC reactor cannot be used.

*2: For 30kW to 90kW drives, an additional DC reactor is incorporated in the position shown the figure above.

*3: The noise filter is built in.

*4: External braking resistor (option). Dynamic braking drive circuit (GTR7) is built-in as standard.

*5: To supply a DC power, connect the cables to the PA/+ and PC/- terminals.

*6: If you want to use a DC power supply to operate 30kW or more inverters, be sure to contact your supplier customer support center, because an inrush current limiting circuit is required in such a case.

*7: ⇒ Refer to Section 2.3.2 of instruction manual E6581386 for each switch functions.

*8: The functions assigned to terminals OUT1, VI/II and RR/S4 can be switched by changing parameter settings. ⇒ For details, refer to Section 2.3.2 of instruction manual E6581386.

*9: To supply control power from an external power supply for backing up the control power supplied from the inverter, an optional control power backup device (CPS002Z) is required. In such a case, the backup device is used at the same time with the internal power supply of the inverter.

To back up control power, set the parameter F647 (Control power supply backup option failure monitoring) properly.

⇒ For more information, refer to 6.33.22 of instruction manual E6581386.

*10: For PWR connection conforming to safety standards, refer to Section 9.3 of instruction manual E6581386.

[Standard connection diagram – source logic]

The figure below shows an example of typical wiring in the main circuit 200V 0.4-45kW/400V 0.75-75kW inverter. This inverter has following three setting/monitor modes.

Main circuit power source

400V class:
0.75~75kW Three-phase 380-480V-50/60Hz

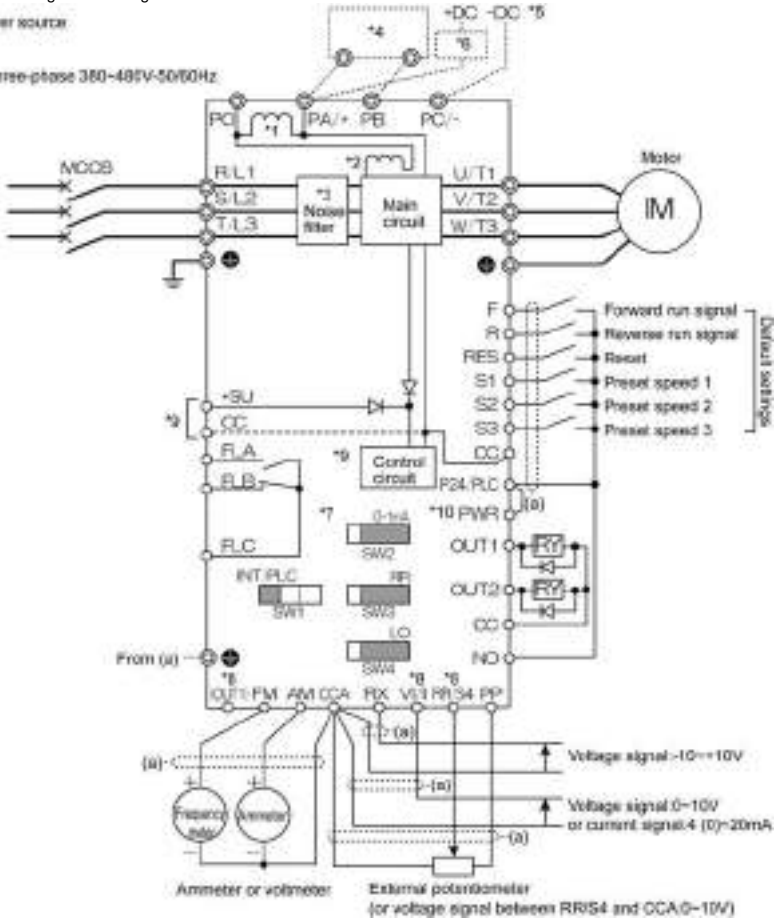

- *1: A DC reactor (DCL) is incorporated in the position shown the figure above. External DC reactor cannot be used.
- *2: For 30kW to 90kW drives, an additional DC reactor is incorporated in the position shown the figure above.
- *3: The noise filter is built in.
- *4: External braking resistor (option). Dynamic braking drive circuit (GTR7) is built-in as standard.
- *5: To supply a DC power, connect the cables to the PA/+ and PC/- terminals.
- *6: If you want to use a DC power supply to operate 30kW or more inverters, be sure to contact your supplier customer support center, because an inrush current limiting circuit is required in such a case.
- *7: ⇒ Refer to Section 2.3.2 of instruction manual E6581386 for each switch functions.
- *8: The functions assigned to terminals OUT1, VI/II and RR/S4 can be switched by changing parameter settings.
⇒ For details, refer to Section 2.3.2 of instruction manual E6581386.
- *9: To supply control power from an external power supply for backing up the control power supplied from the inverter, an optional control power backup device (CPS002Z) is required. In such a case, the backup device is used at the same time with the internal power supply of the inverter.
To back up control power, set the parameter F647 (Control power supply backup option failure monitoring) properly.
⇒ For more information, refer to 6.33.22 of instruction manual E6581386.
- *10: For PWR connection conforming to safety standards, refer to Section 9.3 of instruction manual E6581386.

2.3 Description of terminals

2.3.1 Main circuit terminals

This diagram shows an example of wiring of the main circuit. Use options if necessary.

Power supply and motor connections

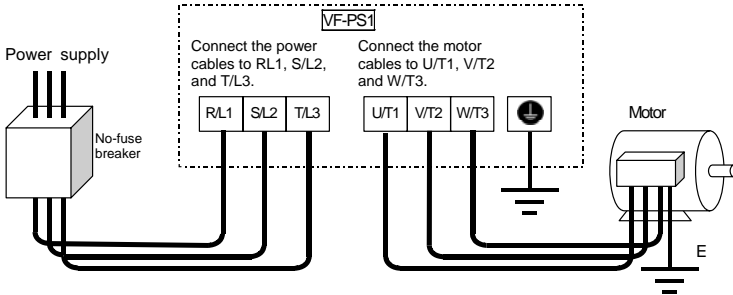

Connection with peripheral equipment

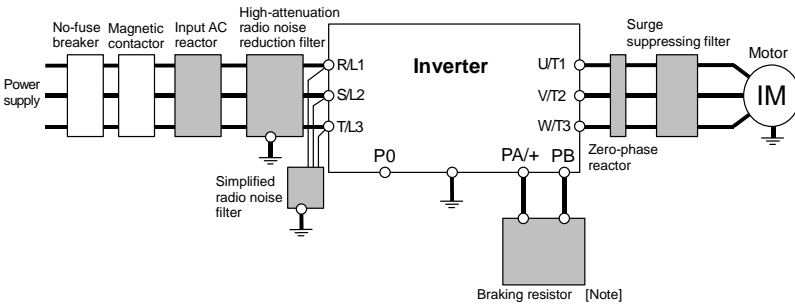

Note) This inverter has a DC reactor included, and has the advantage of reducing input current, reducing harmonics and power factor improvement. So, no DC reactor option is available. In case of requirement of additional reduction of harmonics or more power factor improvement, input AC reactor is recommended.

Main circuit

Terminal symbol	Terminal function
 , PE	Grounding terminal for inverter casing
R/L1, S/L2, T/L3	Power input terminal 0.75~110kW Three-phase 380~480V-50/60Hz
U/T1, V/T2, W/T3	Connect to a (3-phase induction) motor.
PA+, PB	Connect a braking resistor. Change the parameters Pb, Pbr and PbCP if necessary.
PC/-	This is a negative potential terminal in the internal DC main circuit. DC power supply can be input across the PA/+ terminals (positive potential). (For 400V-30kW or more models, an optional circuit is needed to suppress a rush current.)
PO	Do not use.

3. Operations

3.1 Settings to be made at first power on

When the inverter is powered on at the first time after purchase, the Language selection window shown below appears on the LCD panel. In this window, select the language you want to display on the screen.

1. The Language Selection window appears

This window appears only when the unit is turned on at the first time after purchase.

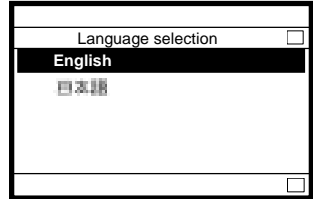

2. Select the desired language using the control dial and push the dial

(In this example, English is selected. There is no need to select/confirm the language.)

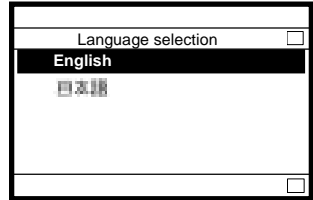

3. The Startup window is displayed and soon replaced by the top window of Top View Mode



*) This shows the version of the installed software. The contents of the window may be somewhat different from those of your LCD panel.

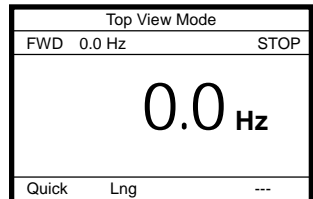

3.2 Setting/monitor modes

This inverter has following three setting/monitor modes.

(1) Top View Mode

When the inverter is powered on, it enters this mode first.

The top window displays the operating status.

In this mode, you can set a panel operation frequency, use a function key as the EASY key, and so on.

⇒ Refer to “3.3. Operation in Top View Mode”.

(2) Parameter Setup Mode

This mode allows you to set parameters.

⇒ Refer to “4. Searching and setting parameters”.

(3) Status Monitor Mode

This mode allows you to monitor various kinds of statuses and information, such as the operating status of the inverter and information on the terminal board.

⇒ Refer to “5. Monitoring the operation status”.

The figures below show the top windows of these modes.

To change from one mode to another, press the [ESC] key.

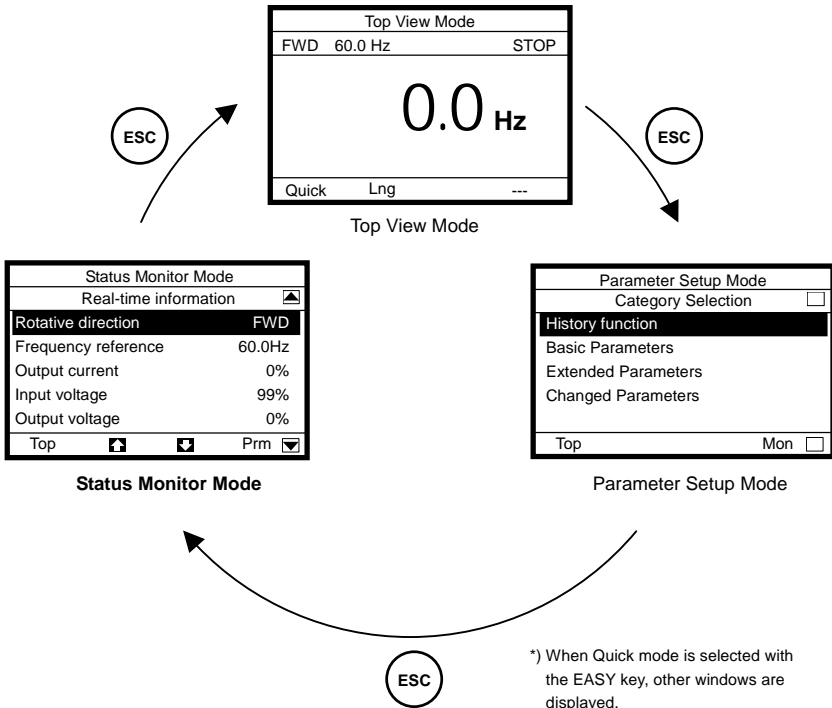

3

3.3 Operation in Top View Mode

When the inverter is powered on, it enters this mode first, which allows you to monitor the operating status, set an operation frequency, use EASY key, and switch between languages. When Panel Jog Run is selected, a jog run frequency also can be specified in this mode.

■ Explanation of the top window

- Display of commands executed:
 "FWD" or "REV" is displayed to indicate the direction of rotation.
 The operation frequency is displayed in the form of "□□. □Hz".
- Display of operating status:
 "RUN" is displayed during operation.
 "STOP" is displayed during a stop.
 "Trip" is displayed in the event of tripping.
- Display of output frequency:
 The operation frequency is displayed in the form of "□□. □Hz".
- Display of alarm/trip:
 In case of alarm or trip, Its code is displayed.
- Display of alarm/trip information:
 In case of alarm or trip, Its information is displayed.

Display of commands executed Display of operating status

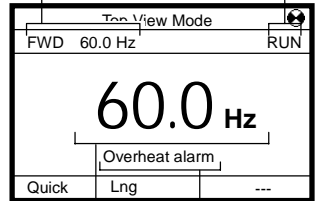

Quick Lng ---

(F1) (F2)

Display of output frequency
 Display of alarm/trip
 Display of alarm/trip message

Functions of function keys

- (F1) : Switches between Quick mode and Standard Setting mode.
- (F2) : Goes to the Language selection window.

3.3.1 Setting a panel operation frequency

Only when Frequency input mode selection 1 (parameter "FMOd") is set at "4", panel operation frequency setting is activated.

1. Press the control dial.

The panel frequency window appears.
 The current operation frequency setting is displayed at the center of the window.
 The current output frequency is displayed in the upper right section of the window.
 The minimum allowable frequency (min) and the maximum allowable frequency (max) are displayed at the bottom of the window.

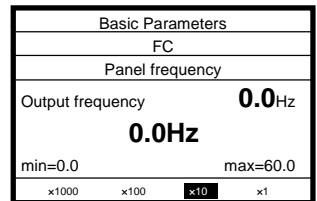

Functions of function keys

- The functions keys allow you to select the position or decimal place of each figure (operation frequency) you want to increment or decrement with the control dial.
- (F1) : Selects the position of 1000 times of minimum setting unit.
 - (F2) : Selects the position of 100 times of minimum setting unit.
 - (F3) : Selects the position of 10 times of minimum setting unit.
 - (F4) : Selects the position of minimum setting unit (In this case, 0.1).

2. After selecting the position of a figure you want to change, specify/confirm a value with the control dial.

(In this example, 30.0Hz is specified.)

Functions of function keys

The functions keys allow you to select the position or decimal place of each figure (operation frequency) you want to increment or decrement with the control dial.

- (F1)** : Selects the position of 1000 times of minimum setting unit.
- (F2)** : Selects the position of 100 times of minimum setting unit.
- (F3)** : Selects the position of 10 times of minimum setting unit.
- (F4)** : Selects the position of minimum setting unit (In this case, 0.1).

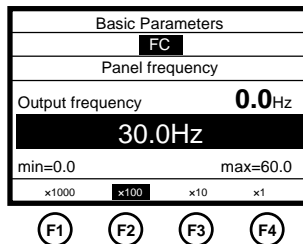

When you confirm the value specified, the screen goes back to the top window of Top View Mode.

■ To change the frequency during operation

Press the control dial during operation to display the operation panel operation frequency menu and turn the control dial to change the setting.

3.3.2 Using an EASY key function

The [F1] function key can be used as a substitute for the EASY key described in the manual E6581386 5.22. The name of the function assigned to the [F1] key is displayed in the lower left corner of the window, and the [F1] key can be used as the EASY key.

- "Quick" : Quick mode / standard setting mode switching (F750=0)
- "Loc/Rem" : Local / Remote key (F750=2)
- "Update" : Monitor peak / minimum hold trigger (F750=3)

* Shortcut key function (F750=1) cannot be used. Even if the parameter is set so, the name of the function is not displayed on the screen.

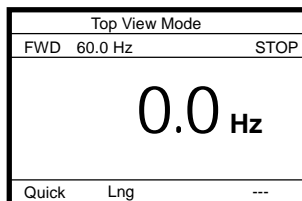

- Quick
- Loc/Rem
- Update

(1) Quick mode / standard setting mode switching function

<Standard Setting mode is selected at power on (parameter PSEL=0)>

- When power is turned on, "Quick" is displayed. ([F1] key is in OFF State)
In this case, top window of Parameter Setup Mode is ordinary one.
- If the [F1] key is pressed while "Quick" is displayed, it turns to highlighted "Quick". ([F1] key is in ON State)
In this case, the Quick mode window appears as the top window of Parameter Setup Mode.

<Quick mode is selected at power on (parameter PSEL=1)>

- When power is turned on, highlighted "Quick" is displayed. ([F1] key is in OFF State)
In this case, the Quick mode window appears as the top window of Parameter Setup Mode.
- If the [F1] key is pressed while "Quick" is displayed, it turns to normal "Quick". ([F1] key is in ON State)
In this case, top window of Parameter Setup Mode is ordinary one.

<Always Quick mode (parameter PSEL=2)>

- Highlighted "Quick" is displayed.
The Quick mode window appears as the top window of Parameter Setup Mode.
* In this case, [F1] key is not active.

(2) Local / Remote key function

- "Loc/Rem" is displayed. ([F1] key is in OFF State)
In this state, remote controlled operation via terminal board is available.
- If the [F1] key is pressed while "Loc/Rem" is displayed, it turns to "Loc/Rem". ([F1] key is in ON State)
In this state, local operation with operation panel is available.
There is no need to switch to local operation mode by changing parameter settings.
* [F1] key is not active while the drive is operating.

(3) Monitor peak / minimum hold trigger function

- "Update" is displayed. ([F1] key is in OFF State)
In this case, the instant the [F1] key is pressed a measurement for peak / minimum hold starts. While the [F1] key is pressed, highlighted "Update" is displayed. ([F1] key is in ON State)

3.3.3 Selecting a language to be displayed

A language to be displayed on the screen can be selected between Japanese and English.
In this window, the language selected at the first power on can also be changed to the other language.

1. Press the [F2] (Lng) key.

The Language selection window appears on the screen.
The language selected is highlighted and marked with a checkmark.

Functions of function keys

(F1) : Goes to the Top View Mode.

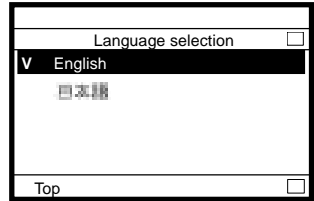

(F1)

2. Select/confirm the desired language with the control dial.

(In this example, Japanese is selected.)

Functions of function keys

(F1) : Goes to the Top View Mode.

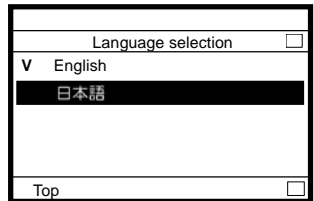

(F1)

3.3.4 Performing jog run

When Panel Jog Run is selected (parameter F262=1, CMOd=1), "JOG" is displayed in the lower right corner of the window. When "JOG" is displayed, jog run can be performed using the [F4] key.

The switching to jog run cannot be performed during operation. When switching to Jog Run mode, operation has to be stopped temporarily.

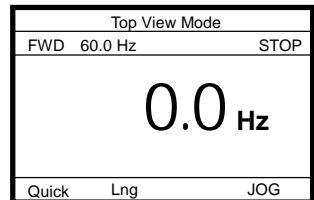

1. Press the [F4] key to carry out jog run.

The jog run frequency is displayed on the screen.
 (In this example, the operation frequency is set at 5.0Hz.)
 Operation continues as long as the [F4] key is pressed,
 and it stops when the [F4] key is released.

Functions of function keys

- (F1)** : Switches between Quick mode and Standard Setting mode.
- (F2)** : Goes to the Language selection window.
- (F4)** : Executes a jog run command.

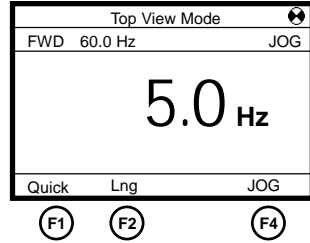

3.3.5 Emergency stop / reset operation

To make an emergency stop or to reset the inverter, follow these steps. An emergency stop can be made when operation is performed with the terminal board inputs (parameter CM0d=0, 2, 3 or 4).

1. Press the [STOP/RESET] key.

Blinking code **EOFF** is displayed in the upper right corner of the window.

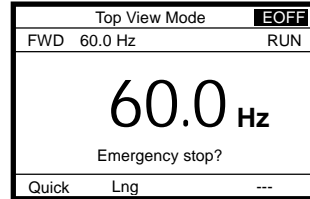

2. Then press the [STOP/RESET] key again.

The Emergency Stop window appears and the blinking code "E" is displayed.

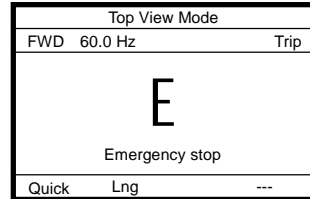

3. Then press the [STOP/RESET] key again.

The Trip window appears and the blinking code "CLr" is displayed.

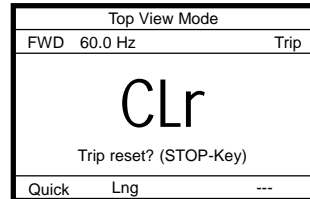

4. Last of all, press the [STOP/RESET] key once again to reset the inverter.

3

4. Searching and setting parameters

In the Parameter Setup Mode, you can set basic parameters and extended parameters.

This mode also allows you to use the history function (parameter "R U H" in the manual E6581386) and the changed parameter search function (parameter "C R U" in the manual E6581386) easily by simply selecting the desired function from a menu.

Functions of function keys

- F1** : Goes to the Top View Mode.
- F4** : Goes to the Status Monitor Mode.

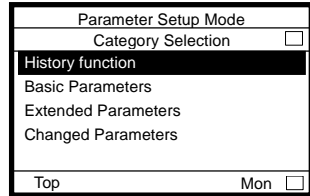

F1

F4

■ When Quick mode is selected

The window shown in the figure right appears when Quick mode is selected.

This window displays the parameter currently selected for Quick mode.

Functions of function keys

- F1** : Goes to the Top View Mode.
- F2** : Displays the previous window.
- F3** : Displays the next window.
- F4** : Goes to the Status Monitor Mode.

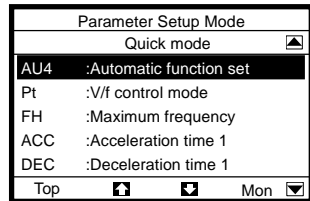

F1

F2

F3

F4

4

4.1 Searching for the change histories of parameters (History function)

The change histories of recent 5 parameters can be displayed in a list form.

1. Select/confirm "History function" using the control dial.

The change histories beginning at the latest one are displayed.

If the number of change histories exceeds 5, the oldest history is deleted.

Functions of function keys

- F1** : Goes to the Top View Mode.

■ In this window, settings can be changed.

By pressing the control dial, it displays the parameter setting window, in which you can change settings as required.

⇒ For the steps to be followed, see the following pages.

4.2 Setting a basic parameter

When Quick mode is selected using the EASY key function, skip step 1. Go straight to step 2.

1. Select/confirm “Basic parameters” using the control dial.

The Basic Parameters window appears.

Functions of function keys

- F1** : Goes to the Top View Mode.
- F2** : Displays the previous window.
- F3** : Displays the next window.

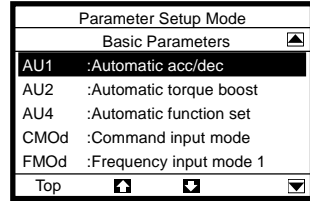

2. Select/confirm the parameter you want to change, using the control dial.

(Ex. Select/confirm “Command input mode” and “Base frequency 1.”)

The Parameter Setting window appears.

If the selected parameter is changed by selecting a menu item, the menu item selected is highlighted and marked with a checkmark.

Functions of function keys

- F2** : Displays the previous window.
- F3** : Displays the next window.

- If the setting selected is changed by selecting a menu item

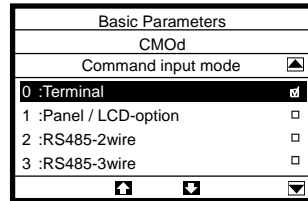

If the selected parameter is changed by specifying a value, the value specified is displayed. In addition, the minimum allowable value (min) and the maximum allowable value (max) are displayed at the bottom of the window.

Functions of function keys

The functions keys allow you to select the position or decimal place of each figure (operation frequency) you want to increment or decrement with the control dial.

- F1** : Selects the position of 1000 times of minimum setting unit.
- F2** : Selects the position of 100 times of minimum setting unit.
- F3** : Selects the position of 10 times of minimum setting unit.
- F4** : Selects the position of minimum setting unit (In this case, 0.1).

- If the setting selected is changed by specifying a value

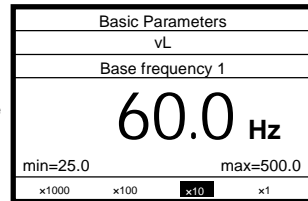

3. Using the control dial, select/confirm an item or specify/confirm a value.

(In this example, "Panel / LCD-option" is selected and confirmed or frequency of 90.0Hz is specified and confirmed.)

When the change you made is saved, the title of the parameter stops blinking and the screen returns to the previous window.

- If the setting selected is changed by selecting a menu

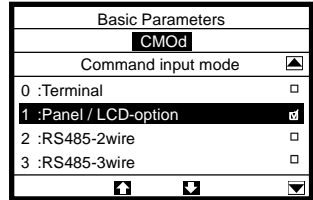

- If the setting selected is changed by specifying a value

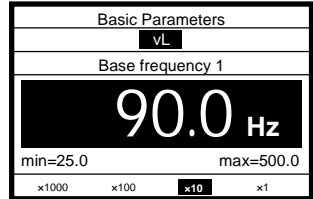

4

4.3 Setting an extended parameter

1. Select/confirm "Extended parameters" using the control dial.

The Extended Parameters window appears.

Functions of function keys

- (F1) : Displays parameters in the number range of 900.
The number displayed decrements each time this key is pressed.
- (F2) : Displays the previous window.
- (F3) : Displays the next window.
- (F4) : Displays parameters in the number range of 900.
The number displayed increments each time this key is pressed.

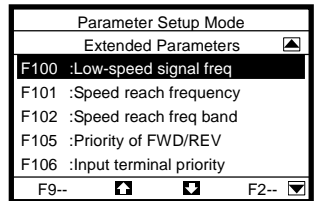

2. Change the parameter setting.

To do this, perform steps 2 and 3 in the "3.2 Setting a basic parameter" section.

4.4 Searching for parameters whose setting has been changed (Changed Parameters)

This function displays parameters whose current settings are different from their default settings, and their present settings.

1. Select/confirm “Changed Parameters” using the control dial.

The Changed Parameters window appears.

Functions of function keys

- (F1)** : Goes to the Top View Mode.
- (F3)** : Displays, in reverse order, parameters whose setting were changed.
- (F4)** : Displays, in normal order, parameters whose setting were changed.

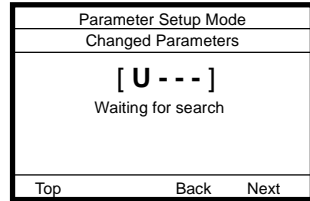

(F1)

(F3)

(F4)

2. Search for the desired parameter by pressing the [F3] or [F4] key repeatedly.

The title, function and current setting of the parameter selected are displayed.

Functions of function keys

- (F1)** : Goes to the Top View Mode.
- (F3)** : Displays, in reverse order, parameters whose setting were changed.
- (F4)** : Displays, in normal order, parameters whose setting were changed.

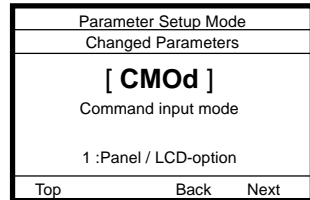

(F1)

(F3)

(F4)

■ In this window, settings can be changed.

By pressing the control dial, it displays the parameter setting window, in which you can change settings as required.

⇒ For the steps to be followed, see the previous sections.

5. Monitoring the operation status

In the Status Monitor Mode, you can monitor various kinds of statuses and information, such as the operating status of the inverter, information on the terminal board, and trip information.

Functions of function keys

- F1** : Goes to the Top View Mode.
- F2** : Displays the previous window.
- F3** : Displays the next window.
- F4** : Goes to the Parameter Setup Mode.

Status Monitor Mode	
Real-time information	
Rotative direction	FWD
Frequency reference	60.0Hz
Output current	22%
Input voltage	99%
Output voltage	50%
Top	Prm



Here are the items that can be monitored in this mode and an explanation of them.

Items displayed	Description	Display of details
Rotative direction	Rotating direction	-
Frequency reference *1	Set item of parameter F711 and its current value	v
Output current *1	Set item of parameter F712 and its current value	v
Input voltage *1	Set item of parameter F713 and its current value	v
Output voltage *1	Set item of parameter F714 and its current value	v
Input terminal 1 : S4,S3...R,F	Input terminal board information (Standard terminal board)	v
Input terminal 2 : L8,L7...L2,L1	Input terminal board information (Optional terminal board)	v
Output terminal 1 : FL,OUT1,OUT2	Output terminal board information (Standard terminal board)	v
Output terminal 2 : R4,R3...OT4,OT3	Output terminal board information (Optional terminal board)	v
Version of APP-CPU	CPU2 version information (Application)	-
Version of MOT-CPU	CPU2 version information (Motor)	-
Past trip # 1 (latest)	Trip history information 1 (latest)	v
Past trip # 2	Trip history information 2	v
Past trip # 3	Trip history information 3	v
Past trip # 4	Trip history information 4	v
Parts replacement alarm	Parts replacement alarm information	v
Cumulative run time	Cumulative run time informatiton	-

*1: The display item shows the case of a default setting.

5.1 Displaying details of an item monitored

1. Select/confirm the desired item using the control dial.

(Ex. Select/confirm "Output current")

The monitor window of the item selected appears.

* Depending on the item selected, no monitor window may be displayed.

Functions of function keys

F1 : Goes to the Top View Mode.

F4 : Goes to the Parameter Setup Mode.

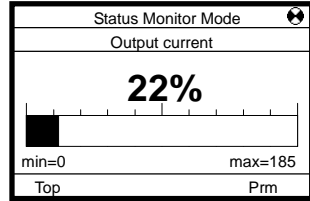

■ How to use monitor windows

Monitor windows can be broadly classified under the following three types

<Type of window 1: Displays a value and a graph>

This type of window displays an analog value, such as an output frequency, output current or output voltage.

(Ex. "Output current")

It displays the current value in both of numerical form and graph form.

In addition, the minimum allowable value (min) and the maximum allowable value (max) are also displayed at the bottom of the window.

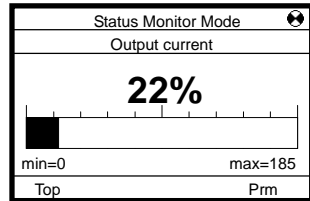

<Type of window 2: Displays information in a graph form>

This type of window displays input/output terminal information and parts replacement alarm.

(Ex. "Input terminal : S4, S3...R, F")

It displays the ON/OFF status of each terminal signal or alarm signal in a graph form.

If the arrow  is moved to a terminal or alarm symbol, the name of the function assigned to the terminal or the name of the alarm is displayed.

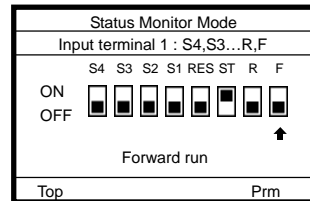

<Type of window 3: Displays information in a list form>

This type of window displays detailed past trip information.

(Ex. Past trip # 1 (latest))

It displays the conditions under which the inverter was operated at the occurrence of tripping.

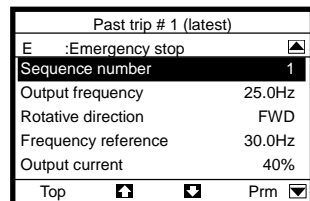

6. List of function key functions

Each function key is corresponding to the function whose abbreviation or graphic symbol is displayed at the bottom of the window and over the key. And by pressing a function key, corresponding function is performed.

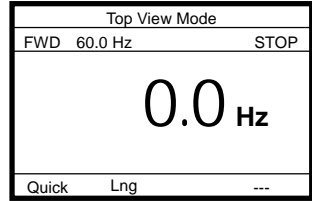

Press the [F1] key to perform this function.

Press the [F2] key to perform this function.

Press the [F3] key to perform this function.

Press the [F4] key to perform this function.

Here are the functions keys available and their functions.

Function key	Display		Function	Reference
	Position	Item		
[F1] key	Far left	Quick	Switches between Quick mode and Standard Setting mode.	3. 3. 2
		Loc/Rem	Switches between Local and Remote.	3. 3. 2
		Update	Measurement for Peak/Minimum Hold starts.	3. 3. 2
		Top	Goes to the Top View Mode.	3. 2
		F9-- ~ F1--	Displays parameters in the number range of 900 ~ displays parameters in the number range of 100.	4. 3
		x1000	Selects the position of 1000 times of minimum setting unit.	3. 3. 1
[F2] key	Left center	Lng	Goes to the Language selection window.	3. 3. 3
			Displays the previous window.	4.
		x100	Selects the position of 100 times of minimum setting unit.	3. 3. 1
[F3] key	Right center		Displays the next window.	4.
		x10	Selects the position of 10 times of minimum setting unit.	3. 3. 1
		Back	Displays, in reverse order, parameters whose setting were changed.	4. 4
[F4] key	Far right	---	No function.	-
		Mon	Goes to the Status Monitor Mode.	3. 2
		Prm	Goes to the Parameter Setup Mode	3. 2
		F1-- ~ F9--	Displays parameters in the number range of 100 ~ displays parameters in the number range of 900.	4. 3
		x1	Selects the position of minimum setting unit.	3. 3. 1
		Next	Displays, in normal order, parameters whose setting were changed.	4. 4
		JOG	Executes a jog run command.	3. 3. 4

7. Measures to satisfy the standards

7.1 How to cope with the CE standards

7.1.1 Measures to satisfy the EMC directive

Concrete measures to EMC directive are shown below.

(1) This inverter installs a EMC filter inside. So the conducted and radiated noise can be reduced.

EMC directive compliance			
Inverter type form	Requirements		Conducted noise level
	PWM carrier frequency CF (kHz)	Length of motor connecting cable (m)	
VFPS1-4007PLE~VFPS1-4055PLE	2~4	10	IEC61800-3 category C2 (EN55011 class A Group 1)
	4.1~16	5	
VFPS1-4075PLE~VFPS1-4185PLE	2~4	10	IEC61800-3 category C3 (EN55011 class A Group 2)
	4.1~16	5	
VFPS1-4220PLE	2~16	25	
VFPS1-4300PLE~VFPS1-4900PLE	2~2.5	50	
	2.6~16	25	
VFPS1-4007PDE~VFPS1-4150PDE	2~16	20	IEC61800-3 category C1 (EN55011 class B Group 1)
		50	IEC61800-3 category C2 (EN55011 class A Group 1)
		100	IEC61800-3 category C3 (EN55011 class A Group 2)
VFPS1-4185PDE~VFPS1-4450PDE	2~16	25	IEC61800-3 category C1 (EN55011 class B Group 1)
		50	IEC61800-3 category C2 (EN55011 class A Group 1)
		100	IEC61800-3 category C3 (EN55011 class A Group 2)
VFPS1-4550PDE~VFPS1-4900PDE	2~8	25	IEC61800-3 category C1 (EN55011 class B Group 1)
		50	IEC61800-3 category C2 (EN55011 class A Group 1)
	2~16	100	IEC61800-3 category C3 (EN55011 class A Group 2)

(2) Use shielded power cables and control signal cables for the input and output lines of the inverter. Route the cables and wires so as to minimize their lengths. Keep a distance between the power cable and the control cable and between the input and output wires of the power cable. Do not route them in parallel or bind them together, instead cross at right angle.

(3) To limit the radiation noise from cables, fix the motor cable to the wiring port plate with metal cable gland.

(4) To further limit the radiation noise, insert a zero-phase reactor in the inverter output line and insert ferrite cores in the earth cables.

7

■ Ex. Countermeasure – inverter wiring

PLE - type

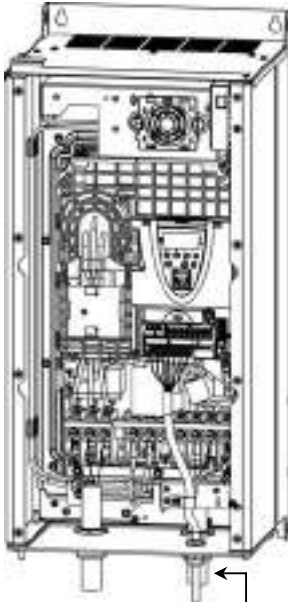

PDE - type

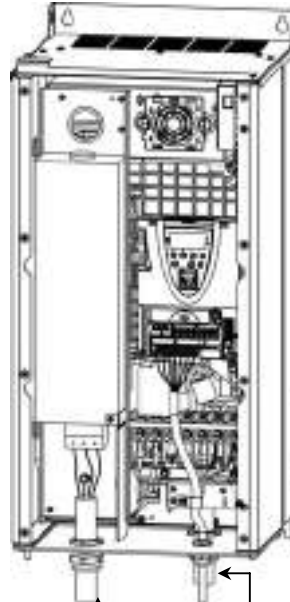

7

Power supply wiring (Shielded cables)
R/L1, S/L2, T/L3
(Fix with nonmetal cable gland)

Control wiring (Shielded cables)
Login input/output +SU, F, R, S1-S3
RES, PWR, NO,
P24/PLC, OUT1,
OUT2, CC
(Fix with nonmetal cable gland)

Motor wiring (Shielded cables)
U/T1, V/T2, W/T3
(Fix with metal cable gland)

Power supply wiring (Shielded cables)
R/L1, S/L2, T/L3
(Fix with nonmetal cable gland)

Control wiring (Shielded cables)
Login input/output +SU, F, R, S1-S3
RES, PWR, NO,
P24/PLC, OUT1,
OUT2, CC
(Fix with nonmetal cable gland)

Motor wiring (Shielded cables)
U/T1, V/T2, W/T3
(Fix with metal cable gland)

Note1) For cables other than above, refer to the example of countermeasure in instruction manual E6581386 9.1.2.
Note2) Wiring port plate have holes only for cables listed in above. In case of wiring other cables, please add hole for each cable.

■ Mounting and connecting the shielded motor cable with metal cable gland (not supplied with the drive)

Fix the motor cable to the wiring port plate with metal cable gland with reference to the figure below.

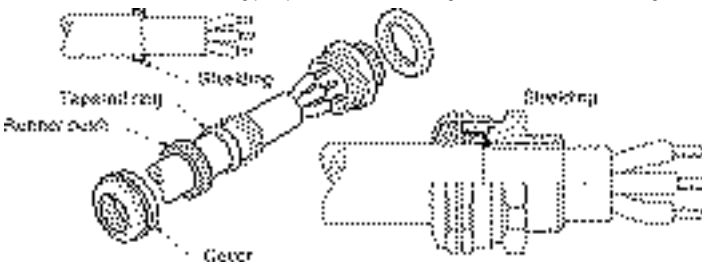

■ Wiring port plate

PLE – type

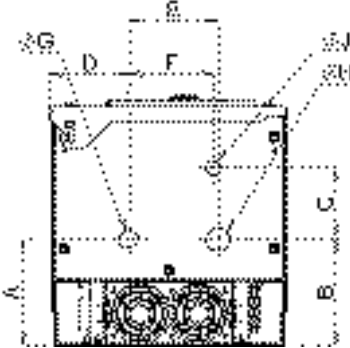

PDE - type

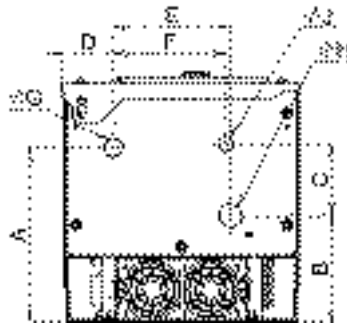

	A (mm)	B (mm)	C (mm)	D (mm)	E (mm)	F (mm)	G (mm)	H (mm)	J (mm)
4007PLE~4022PLE	97.5	97.5	84	91.5	83	74	20.5 (20.7)	25.5 (22.8)	16.5 (18.8)
4037PLE, 4055PLE	111.5	111.5	84	91.5	83	74	20.5 (20.7)	25.5 (22.8)	16.5 (18.8)
4075PLE, 4110PLE	117.9	117.9	78.5	86.5	98	93	20.5 (20.7)	25.5 (22.8)	16.5 (18.8)
4150PLE	148.2	141.2	84	78.8	132	132	32.5 (37.4)	25.5 (28.6)	16.5 (18.8)
4185PLE, 4220PLE	155.2	148.2	80	88.8	132	144	32.5 (37.4)	32.5 (28.6)	16.5 (18.8)
4300PLE	158.4	158.4	84	73.8	141	139	40.5 (47.5)	40.5 (37.4)	16.5 (18.8)
4370PLE, 4450PLE	167.5	167.5	96	76.8	141	138	50.5 (47.5)	40.5 (37.4)	16.5 (18.8)
4550PLE~4900PLE	189	191	97	69.5	207	228	63.5 (60.5)	50.5 (47.5)	16.5 (18.8)
4007PDE~4022PDE	175.5	97.5	84	44.5	130	121	20.5 (20.7)	25.5 (22.8)	16.5 (18.8)
4037PDE, 4055PDE	189.5	111.5	84	44.5	130	121	32.5 (20.7)	25.5 (22.8)	16.5 (18.8)
4075PDE, 4110PDE	192.9	117.9	78.5	56.5	128	123	32.5 (20.7)	25.5 (22.8)	16.5 (18.8)
4150PDE	233.2	141.2	84	73.8	137	137	32.5 (37.4)	25.5 (28.6)	16.5 (18.8)
4185PDE, 4220PDE	240.2	148.2	80	88.8	132	144	32.5 (37.4)	32.5 (28.6)	16.5 (18.8)
4300PDE	226.5	158.5	84	74	141	139	40.5 (47.5)	40.5 (37.4)	16.5 (18.8)
4370PDE, 4450PDE	251.5	167.5	96	76.8	141	138	50.5 (47.5)	40.5 (37.4)	16.5 (18.8)
4550PDE~4900PDE	271	191	97	106	170.5	191.5	63.5 (60.5)	50.5 (47.5)	16.5 (18.8)

Note) Values in () are for UL Type 12 conformity type. Drives with UL Type 12 conformity are optional. Contact your nearest Toshiba inverter distributor for them.

7.2 Measurements to be taken to satisfy the UL/CSA standards

7.2.1 Caution as to peripheral devices

When installing a no-fuse circuit breaker or a fuse box on the primary side of the inverter, use UL-certified one.

The UL certification test on this inverter was conducted under the AIC* conditions shown in table below (*: current that flows in the event of a short-circuit in the power supply). Note that AIC currents vary depending on the capacity of the motor used.

AIC and maximum input voltage

Applicable motor (kW)	AIC (A)	Maximum input voltage (V)
0.4 - 37	5,000	480
45 - 90	10,000	

AIC, Fuse and Wire sizes

Applicable motor (kW)	Inverter type form	UL Output current(A) *1, *2	AIC (A) (Interrupting capacity)	Fuse class and current (A)	Input wire size of power circuit (AWG) *3	Output wire size of power circuit (AWG) *3	Grounding wire (AWG) *3
0.75	VFPS1-4007PLE/PDE	2.1 (CF=8)	AIC 5000A	CC 6Amax.	14	14	14
1.5	VFPS1-4015PLE/PDE	3.4 (CF=8)	AIC 5000A	CC 6Amax.	14	14	14
2.2	VFPS1-4022PLE/PDE	4.8 (CF=8)	AIC 5000A	CC 12Amax.	14	14	14
3.7	VFPS1-4037PLE/PDE	7.6 (CF=8)	AIC 5000A	J 15Amax.	12	12	14
5.5	VFPS1-4055PLE/PDE	11.0 (CF=8)	AIC 5000A	J 25Amax.	10	10	12
7.5	VFPS1-4075PLE/PDE	14.0 (CF=8)	AIC 5000A	J 40Amax.	10	10	12
11	VFPS1-4110PLE/PDE	21.0 (CF=8)	AIC 5000A	J 40Amax.	8	8	10
15	VFPS1-4150PLE/PDE	27.0 (CF=8)	AIC 5000A	J 60Amax.	6	6	10
18.5	VFPS1-4185PLE/PDE	34.0 (CF=4)	AIC 5000A	J 70Amax.	6	6	10
22	VFPS1-4220PLE/PDE	40.0 (CF=4)	AIC 5000A	J 70Amax.	6	6	10
30	VFPS1-4300PLE/PDE	52.0 (CF=4)	AIC 5000A	J 80Amax.	4	4	10
37	VFPS1-4370PLE/PDE	65.0 (CF=4)	AIC 5000A	J 90Amax.	3	3	8
45	VFPS1-4450PLE/PDE	77.0 (CF=4)	AIC 10000A	J 110Amax.	1	1	8
55	VFPS1-4550PLE/PDE	96.0 (CF=4)	AIC 10000A	J 150Amax.	1/0	1/0	6
75	VFPS1-4750PLE/PDE	124.0 (CF=4)	AIC 10000A	J 175Amax.	3/0	3/0	6
90	VFPS1-4900PCE/PDE	156.0 (CF=4)	AIC 10000A	J 225Amax.	250MCM	250MCM	2

*1: UL output current is different from unit rating output current.

*2: The value of the UL rated output current is applicable when the carrier frequency (CF) is less than the value shown in the table.

*3: The cables used must be 75°C copper cables within 40°C ambient temperature.

7.2.2 Conforming to UL Type 12

Drives with UL Type 12 conformity are optional. Contact your nearest Toshiba inverter distributor for them.

8. Selection of peripheral devices

8.1 Selection of wiring materials and devices

Applicable motor (kW)	Inverter type form	Wire size											
		Main circuit				DC terminal (optional)		Braking resistor / Braking unit (Optional)		Earth cable			
		Input terminal (R,S,T)		Output terminal (U,V,W)		AWG	mm ²	AWG	mm ²	AWG	mm ²	AWG	mm ²
		AWG	mm ²	AWG	mm ²								
0.75	VFPS1-4007PLE/PDE	14	1.5	14	1.5	14	1.5	14	1.5	14	1.5	14	2.5
1.5	VFPS1-4015PLE/PDE	14	1.5	14	1.5	14	1.5	14	1.5	14	1.5	14	2.5
2.2	VFPS1-4022PLE/PDE	14	1.5	14	1.5	14	1.5	14	1.5	14	1.5	14	2.5
3.7	VFPS1-4037PLE/PDE	12	1.5	12	1.5	14	1.5	14	1.5	14	1.5	14	2.5
5.5	VFPS1-4055PLE/PDE	10	1.5	10	1.5	12	1.5	14	1.5	14	1.5	14	2.5
7.5	VFPS1-4075PLE/PDE	10	1.5	10	2.5	10	2.5	14	1.5	14	1.5	14	2.5
11	VFPS1-4110PLE/PDE	8	4	8	4	8	4	10	2.5	12	4	10	6
15	VFPS1-4150PLE/PDE	6	6	6	6	8	6	10	4	10	6	10	6
18.5	VFPS1-4185PLE/PDE	6	6	6	6	6	10	8	6	10	6	10	6
22	VFPS1-4220PLE/PDE	6	10	6	10	4	16	8	10	10	10	10	10
30	VFPS1-4300PLE/PDE	4	16	4	16	4	25	4	16	4	16	4	16
37	VFPS1-4370PLE/PDE	3	25	3	25	2	25	4	25	4	16	4	16
45	VFPS1-4450PLE/PDE	1	25	1	25	1	35	3	25	4	16	4	16
55	VFPS1-4550PLE/PDE	1/0	35	1/0	35	2/0	50	2	35	2	35	2	35
75	VFPS1-4750PLE/PDE	3/0	70	3/0	70	4/0	95	1/0	70	2	35	2	35
90	VFPS1-4900PLE/PDE	250MCM	95	250MCM	70	250MCM	120	2/0	95	2	35	2	35

(*1): The recommended cable size is that of the cable (e.g. 600V class, HIV cable) with continuous maximum permissible temperature of 75°C. The ambient temperature is assumed to be 40°C or below. (The interconnect cable length is assumed to be 30m or less.)

(*2): For the control circuit, use shielded wires whose size (cross-section) is 0.75mm² or more.

(*3): For the earth cable, use wires larger than the specified ones in size (cross-section).

(*4): Recommended wire size for an optional braking resistor. Refer to instruction manual E6581386 5.19 for use of external braking resistor.

■ Selection of wiring equipment

Applicable motor (kW)	Inverter type form	Input current [A]	No-fuse breaker (MCCB)	Magnetic contactor (MC)	
			Rated current [A]	Rated current [A]	AC-1
0.75	VFPS1-4007PLE/PDE	1.8	4		25
1.5	VFPS1-4015PLE/PDE	3.5	6.3		25
2.2	VFPS1-4022PLE/PDE	5	10		25
3.7	VFPS1-4037PLE/PDE	8.8	14		25
5.5	VFPS1-4055PLE/PDE	11.4	25		25
7.5	VFPS1-4075PLE/PDE	15.8	25		25
11	VFPS1-4110PLE/PDE	21.9	30		32
15	VFPS1-4150PLE/PDE	30.5	40		40
18.5	VFPS1-4185PLE/PDE	37.5	60		50
22	VFPS1-4220PLE/PDE	43.6	60		50
30	VFPS1-4300PLE/PDE	56.7	100		80
37	VFPS1-4370PLE/PDE	69.5	100		125
45	VFPS1-4450PLE/PDE	85.1	125		125
55	VFPS1-4550PLE/PDE	104.8	150		125
75	VFPS1-4750PLE/PDE	140.3	200		250
90	VFPS1-4900PLE/PDE	171.8	200		250

(*1): Selections for use of the Toshiba 4-pole standard motor with power supply voltage of 400V-50Hz.

(*2): Choose the MCCB according to the power supply capacity.

For comply with UL and CSA standard, use the fuse certified by UL and CSA.

(*3): When using on the motor side during commercial-power supply operation, choose the MC with class AC-3 rated current for the motor rated current.

(*4): Attach surge killers to the magnetic contactor and exciting coil of the relay.

(*5): In the case the magnetic contactor (MC) with 2a-type auxiliary contacts is used for the control circuit, raise the reliability of the contact by using 2a-type contacts in parallel connection.

9. Table of parameters

For parameters, refer to the instruction manual E6581386. However, for totally enclosed box type drives, only following points are different.

Title	Communication No.	Function	Adjustment range
CF	0300	PWM carrier frequency	1.0~16.0kHz *1

*1: Although instruction manual E6581386 describes that the carrier frequency is adjustable between 2.5 to 8.0kHz for 90kW model, it is adjustable between 1.0 to 16.0kHz for totally enclosed box type 90kW model.

For standard default settings, refer to following table.

Inverter type	Torque boost	Base frequency voltage	Acc/dec time	PWM carrier frequency	Dynamic braking resistance	Allowable continuous braking resistance	Inverter side switching waiting time	Motor rated capacity
	vb F172	vlv F171	ACC/DEC F500/F501	CF	Pbr	PbCP	F356	F405
VFPS1-4007PLE/PDE	8.0	*1	10.0	8.0	200.0	0.12	0.57	0.75
VFPS1-4015PLE/PDE	6.0	*1	10.0	8.0	200.0	0.12	0.57	1.50
VFPS1-4022PLE/PDE	6.0	*1	10.0	8.0	200.0	0.12	0.57	2.20
VFPS1-4037PLE/PDE	6.0	*1	10.0	8.0	160.0	0.12	0.67	3.70
VFPS1-4055PLE/PDE	4.0	*1	10.0	8.0	80.0	0.24	0.87	5.50
VFPS1-4075PLE/PDE	4.0	*1	10.0	8.0	60.0	0.44	0.87	7.50
VFPS1-4110PLE/PDE	4.0	*1	10.0	8.0	40.0	0.66	1.07	11.00
VFPS1-4150PLE/PDE	3.0	*1	10.0	8.0	30.0	0.88	1.07	15.00
VFPS1-4185PLE/PDE	3.0	*1	30.0	4.0	30.0	0.88	1.37	18.50
VFPS1-4220PLE/PDE	3.0	*1	30.0	4.0	15.0	1.76	1.37	22.00
VFPS1-4300PLE/PDE	3.0	*1	30.0	4.0	15.0	1.76	1.37	30.00
VFPS1-4370PLE/PDE	3.0	*1	30.0	4.0	8.0	1.76	1.37	37.00
VFPS1-4450PLE/PDE	3.0	*1	30.0	4.0	8.0	1.76	1.37	45.00
VFPS1-4550PLE/PDE	3.0	*1	30.0	4.0	8.0	1.76	1.37	55.00
VFPS1-4750PLE/PDE	2.0	*1	60.0	4.0	8.0	1.76	1.37	75.00
VFPS1-4900PLE/PDE	2.0	*1	60.0	4.0	3.7	7.40	1.37	90.00

*1: Inverter with a model number ending with -WN:460, -WP:400.

Inverter type	Motor rated current	Motor rated rotation speed	Motor constant1 (torque boost)	Motor constant2 (no load current)	Motor constant3 (leak inductance)	Motor constant4 (rated slip)	Display unit selection for integral output power
	F406	F407 *1	F410	F411	F412	F413	F749
VFPS1-4007PLE/PDE	1.7	1690	7.3	54	100	6.11	0
VFPS1-4015PLE/PDE	3.1	1690	7.1	45	60	6.11	0
VFPS1-4022PLE/PDE	4.5	1680	5.9	41	70	6.67	0
VFPS1-4037PLE/PDE	7.4	1690	4.9	36	70	6.11	1
VFPS1-4055PLE/PDE	10.5	1730	3.9	34	70	3.89	1
VFPS1-4075PLE/PDE	14.1	1730	3.4	33	70	3.89	1
VFPS1-4110PLE/PDE	20.3	1730	2.8	27	60	3.89	1
VFPS1-4150PLE/PDE	27.3	1730	2.5	27	60	3.89	1
VFPS1-4185PLE/PDE	34.0	1750	2.6	27	70	2.78	1
VFPS1-4220PLE/PDE	40.0	1750	2.4	27	70	2.78	1
VFPS1-4300PLE/PDE	54.0	1745	2.2	26	70	3.06	1
VFPS1-4370PLE/PDE	67.0	1750	1.8	27	70	2.78	2
VFPS1-4450PLE/PDE	80.0	1750	1.7	26	60	2.78	2
VFPS1-4550PLE/PDE	98.0	1755	1.6	24	70	2.50	2
VFPS1-4750PLE/PDE	129.0	1775	1.5	28	50	1.39	2
VFPS1-4900PLE/PDE	153.0	1775	1.3	26	50	1.39	2

10. Specifications

10.1 Models and their standard specifications

1) Standard specifications

Item		Specification																
Voltage class		400V class																
Applicable motor (kW)		0.75	1.5	2.2	3.7	5.5	7.5	11	15	18.5	22	30	37	45	55	75	90	
Applicable motor (HP)		1	2	3	5	7.5	10	15	20	25	30	40	50	60	75	100	125	
Rating	Type	VFPS1-																
	Form	PLE type	4007PLE	4015PLE	4022PLE	4037PLE	4055PLE	4075PLE	4110PLE	4150PLE	4185PLE	4220PLE	4300PLE	4370PLE	4450PLE	4550PLE	4750PDE	4900PLE
		PDE type	4007PDE	4015PDE	4022PDE	4037PDE	4055PDE	4075PDE	4110PDE	4150PDE	4185PDE	4220PDE	4300PDE	4370PDE	4450PDE	4550PDE	4750PDE	4900PDE
	Output capacity (kVA) [Note1]	1.8	3.1	3.9	6.9	9.1	12	17	23	28	33	45	54	65	78	104	124	
	Output current (A) [Note2]	2.3	4.1	5.1	9.1	12	16	22.5	30.5	37	43.5	58.5	71.5	85	103	137	163	
	Output voltage	Three-phase 380~480V(The maximum output voltage is equal to the input supply voltage)																
Overload current rating	110% - 1 minute																	
Electrical braking	Dynamic braking circuit	Built-in dynamic braking drive circuit																
	Dynamic braking resistor	An external braking resistor (optional)																
Power supply	Voltage-frequency	Three-phase 380~480V-50/60Hz [Note3]																
	Allowable fluctuation	Voltage + 10% - 15% [Note 4] Frequency ±5%																
Protective method		Totally enclosed (JEM1030) IP54 / UL Type 12 [Note 5]																
Cooling method		Forced air-cooled																
Cooling fan noise (dBA)		43	43	43	55	55	56	56	58	60	60	60	64	64	64	64	64	
Color		RAL7016																
EMC filter	PLE type	IEC61800-3 category C2(EN55011 class A Group 1) filter Built-in						IEC61800-3 category C3(EN55011 class A Group 2) filter Built-in										
	PDE type	IEC61800-3 category C1(EN55011 class B Group 1) filter Built-in																
DC reactor		Built-in																

Note 1: Capacity is calculated at 440V.

Note 2: Rated output current when the PWM carrier frequency (parameter CF) is 8kHz or less.

⇒ Refer to 1.4.1 " Derating curves" for details.

Note 3: An external power supply backup available (optional) (Type: CPS002Z)

Note 4: ±10% when the inverter is used continuously (load of 100%).

Note 5: Drives with UL Type 12 conformity are optional. Contact your nearest Toshiba inverter distributor for them.

2) Common specification

	Item	Specification
Control specification	Control system	Sinusoidal PWM control
	Output voltage adjustment	Main circuit voltage feedback control. (Switchable between automatic adjustment/fix/control off)
	Output frequency range	Setting between 0.01 to 500Hz. Default max. frequency is set to 0.01 to 60Hz. Maximum frequency adjustment (30 to 500Hz)
	Minimum setting steps of frequency	0.01Hz: operation panel input (60Hz base), 0.02Hz: analog input (60Hz base, 11 bit/0 to 10Vdc)
	Frequency accuracy	Analog input: $\pm 0.2\%$ of the maximum output frequency (at $25 \pm 10^\circ\text{C}$) Digital input: $\pm 0.01\% \pm 0.022\text{Hz}$ of the output frequency
	Voltage/frequency characteristics	V/f constant, square reduction torque control, automatic torque boost, vector calculation control, base frequency adjustment 1 and 2 (25 to 500Hz), V/f 5-point arbitrary setting, torque boost adjustment (0 to 30%), start frequency adjustment (0 to 10Hz), stop frequency adjustment (0 to 30Hz)
	Frequency setting signal	3k Ω potentiometer (possible to connect to 1 to 10k Ω -rated potentiometer) 0 to 10Vdc (input impedance Zin: 30k Ω) 0 to $\pm 10\text{Vdc}$ (Zin: 22k Ω) 4 to 20mA Δ c (Zin: 242 Ω)
	Terminal board base frequency	The characteristic can be set arbitrarily by two-point setting. Compliant with 6 types of input; analog input (RR, VI/II, RX, RX2), pulse input and binary/BCD input (*RX2, binary/BCD input: optional)
	Frequency jump	3 places. Setting of jump frequency and width.
	Upper and lower limit frequencies	Upper limit frequency: 0 to max. frequency, lower limit frequency: 0 to upper limit frequency
PWM carrier frequency	Adjustable between 1.0 to 16kHz.	
PID control	Adjustment of proportional gain, integral time, differential time and delay filter	
Operation specifications	Acceleration/deceleration time	0.01 to 6000 sec. Selectable from among acceleration/deceleration, times 1 and 2. Automatic acceleration/deceleration function. S-pattern acceleration/deceleration 1 and 2 pattern adjustable.
	DC braking	Adjustment of braking start frequency (0 to 120Hz), braking (0 to 100%) and braking time (0 to 20 sec.). With emergency stop braking function and motor shaft fix control function.
	Forward run/reverse run [Note 1]	With F-CC closed to forward run, with R-CC closed to reverse run, with both closed to reverse run. With ST-CC opened to coast stop. Emergency stop by panel operation or terminal board.
	Jog run [Note 1]	Jog mode, if selected, allows jog operation from the operation panel Jog run operation by terminal board is possible by setting the parameters.
	Preset speed operation [Note 1]	By changing the combination of open/close between S1, S2, S3, RR/S4-CC, set frequency + 15-speed operation. Selectable between acceleration/deceleration time, torque limit and V/f by set frequency.
	Retry	Capable of restarting after a check of the main circuit elements in case the protective function is activated. Max. 10 times selectable arbitrarily. Waiting time adjustment (0 to 10 sec.)
	Soft stall	Automatic load reduction control at overloading. (Default: OFF)
	Cooling fan ON/OFF	The cooling fan will be stopped automatically to assure long life when unnecessary. However, the fan inside the drive will always runs.
	Operation panel key operation ON/OFF control	Key prohibition selectable for frequency setting, etc. All key operations can also be prohibited.
	Regenerative power ride-through control	Possible to keep the motor running using its regenerative energy in case of a momentary power failure. (Default: OFF)
	Auto-restart operation	Possible to restart the motor in coasting in accordance with its speed and direction. (Default: OFF)
	Commercial inverter switching	Possible to switch operation by commercial power source or inverter
	Drooping function	When two or more inverters are used to operate a single load, this function prevents load from concentrating on one inverter due to unbalance.
Override function	External input signal adjustment is possible to the operation frequency command value.	
Protective function	Protective function	Stall prevention, current limit, overcurrent, overvoltage, short circuit on the load side, ground fault on the load side [Note 5], undervoltage, momentary power failure (15ms or more), non-stop control at momentary power failure, overload protection, arm overload at starting, overcurrent on the load side at starting, overcurrent and overload at dynamic braking resistance, fin overheat, emergency stop
	Electronic thermal characteristic	Switchable between standard motor/constant torque VF motor, adjustment of overload protection and stall prevention level.
	Reset	Reset by 1a contact closed (or 1b contact opened), or by operation panel. Or power source OFF/ON. This function is also used to save and clear trip records.

(Continued overleaf)

(Continued)

Item		Specification	
Display function	LCD panel	Alarms	Stall prevention during operation, overload limit, overload, undervoltage on power source side, DC circuit undervoltage, setting error, in retry, upper limit, lower limit.
		Causes of failures	Overcurrent, overvoltage, fin overheat, short circuit on the load side, ground fault on the load side, inverter overload, arm overcurrent at starting, overcurrent on the load side at starting, EEPROM error, RAM error, ROM error, transmission error, (dynamic braking resistor overcurrent/overload), (emergency stop), (undervoltage), (low current), (overtorque), (motor overload), (output phase failure) The items in the parentheses are selectable.
		Monitoring function	Operation frequency, operation frequency command, forward run/reverse run, output current, DC voltage, output voltage, compensated frequency, terminal board input/output information, CPU version, control EEPROM version, past trip history, cumulative operation time, speed feedback, torque, torque command, torque current, exiting current, PID feedback value, motor overload factor, inverter overload factor, PBR overload factor, PBR load factor, input power, output power, peak output current, peak DC voltage, Motor counter pseudo PG, position pulse, RR input, V/II input, RX input, RX2 input, FM output, AM output, meter adjustment fix output, flash memory version, main circuit EEPROM version, types of connection option, previous default setting, previous automatic control (AU2)
		Free unit display	Display of optional units other than output frequency (motor speed, line speed, etc), current ampere/% switch, voltage volt/% switch
		Automatic edit function	Searches automatically parameters that are different from the standard default setting parameters. Easy to find changed parameters.
		User default setting	User parameter settings can be saved as default settings. Allows to reset the parameters to the user-defined parameter settings.
	LED	Charge display	Displays main circuit capacitor charging.
Power Removal safety function		Built-in Power Removal safety function which complies with EN954-1 category 3 and IEC/EN 61508-1 SIL2.	
Input/output terminal input function		Possible to select positive logic or negative logic with programmable input/output terminal function menu. [Note 1] [Note 2] (Default setting: positive logic)	
Sink/source switching		Possible to switch between minus common (CC) and plus common (P24) for control terminal. (Default setting: minus common (CC))	
output signal	Failure detection signal	1c contact output (250Vac-2A-cos Φ =1, 250Vac-1A-cos Φ =0.4, 30Vdc-1A)	
	Low speed/speed reach signal output [Note 2]	Open collector output (24Vdc, max. 50mA, output impedance: 33 Ω)	
	Upper/lower limit frequency signal output [Note 2]	Open collector output (24Vdc, max. 50mA, output impedance: 33 Ω)	
	Output for frequency meter/ Output for ammeter [Note 3]	Analog output. 1mAdc full-scale DC ammeter or 7.5Vdc-1mA voltmeter	
	Pulse train frequency output	Open collector output (24Vdc, max. 50mA)	
Communication function		RS-485 standard 2-channel equipped (connector: modular 8P) CC-Link, DeviceNet and PROFIBUS-DP are optional.	
Environments	Use environments	Indoor use. Altitude: 3000m or less (current reduction necessary if 1000m or more.) Place not exposed to direct sunlight and free of corrosive and explosive gases.	
	Ambient temperature	-10 to +50°C (Remove the upper cover if 40°C or more, max. 60°C) [Note 4]	
	Storage temperature	-25 to +70°C	
	Relative humidity	20 to 93% (free from condensation)	
	Vibration	5.9m/s ² (0.6G) or less (10 to 55Hz) (Compliant with JIS C60068-2-6)	

Note 1: 15 contact input terminals (of which 8 are options) are programmable contact input terminals, and they make it possible to arbitrarily select from about 80 types of signals.

Note 2: Programmable ON/OFF output terminals make it possible to arbitrarily select from about 180 types of signals.

Note 3: Programmable analog output terminals make it possible to arbitrarily select from about 50 types of signals.

Note 4: When using inverters where the ambient temperature will rise above 40°C, derate the output current.

Note 5: This function protects inverters from overcurrent due to output circuit ground fault.

10.2 Outside dimensions and mass

■ Outside dimensions and weight

Applicable motor (kW)	Applicable motor (HP)	Inverter type	Dimensions (mm)					Drawing	Approximate mass (kg) [Note 1]
			W	H	D	W1	H1		
0.75	1	VFPS1-4007PLE(PDE)	240	490	261	200	476	A	13(15)
1.5	2	VFPS1-4015PLE(PDE)							
2.2	3	VFPS1-4022PLE(PDE)							
3.7	5	VFPS1-4037PLE(PDE)	240	490	275	200	476	B	16(18)
5.5	7.5	VFPS1-4055PLE(PDE)							
7.5	10	VFPS1-4075PLE(PDE)							
11	15	VFPS1-4110PLE(PDE)	260	525	275	220	511	C	20(23)
15	20	VFPS1-4150PLE(PDE)							
18.5	25	VFPS1-4185PLE(PDE)							
22	30	VFPS1-4220PLE(PDE)	315	665	305	270	647	E	36(41)
30	40	VFPS1-4300PLE(PDE)							
37	50	VFPS1-4370PLE(PDE)							
45	60	VFPS1-4450PLE(PDE)	285	720	301	245	700	F	34(39)
55	75	VFPS1-4550PLE(PDE)							
75	100	VFPS1-4750PLE(PDE)							
90	125	VFPS1-4900PLE(PDE)	362	1000	353	300	975	H	69(80)

Note 1: The values in parentheses are values for PDE type.

■ Outline drawing

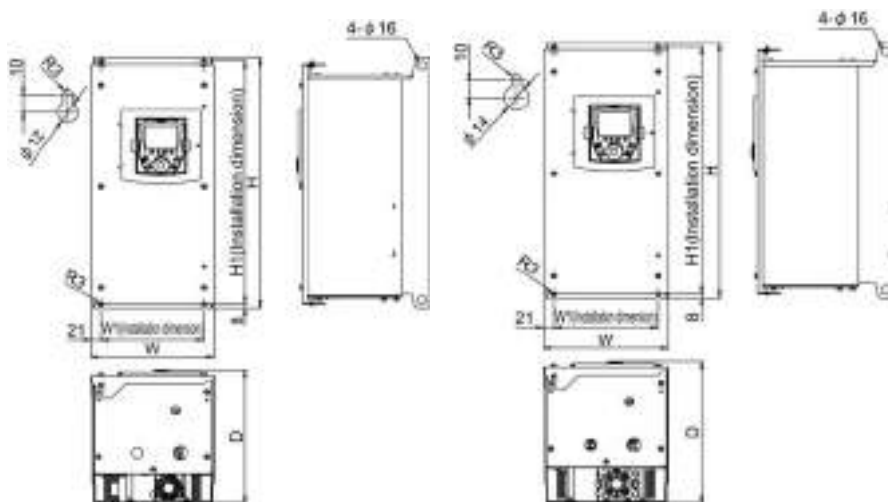

Fig. A

Fig. B



Fig. C

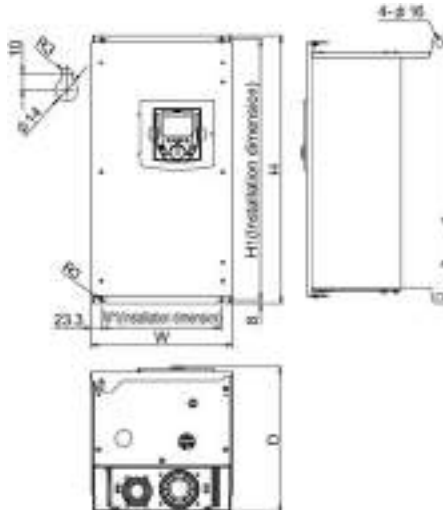

Fig. D



Fig. E

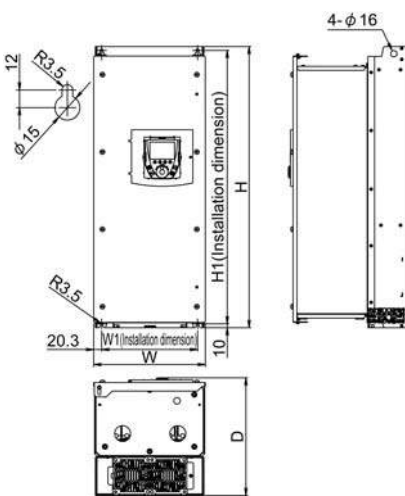

Fig. F



Fig. G

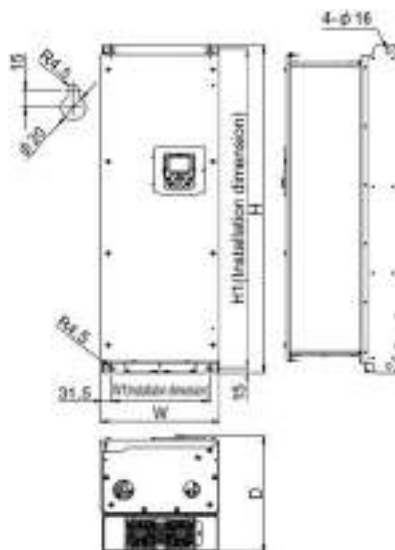

Fig. H